



Ducted Wine Cellar Cooling Systems

Installation, Operation and Maintenance Manual
D025, D050, D088, D0200

Manufactured by:



Wine Guardian reserves the right, without notice, to make changes to this document at its sole discretion.
Please visit our web site for the most current version of the Wine Guardian manual and other literature.
Wine Guardian is a registered trademark (2,972,262) of Air Innovations, Inc.
Edition 09-2015

© Air Innovations 2015

Part No. 15H0127-00

TABLE OF CONTENTS

Directory of Terms	5
Illustrations	6
Receiving, Inspecting and Unpacking the Wine Guardian Unit.....	7
Receiving and Inspecting the Unit	7
Review the Packing Slip to Verify.....	7
Check the unit for.....	7
General Description	8
Standard Specifications	9
The Wine Guardian Unit Contains	9
Accessories and Optional Equipment.....	10
Heating Coils	10
Water Cooled Option	10
Duct Collars and Flexible Ducts	10
Extended Compressor Warranty	10
Low Ambient Option.....	10
Condensate Pump	10
Humidifier and Humidistat	10
High Ambient	10
Overview of the Wine Guardian Unit.....	11
Overview Illustration of the Wine Guardian Unit	12
Overview Illustration of water-cooled system	13
Wiring diagrams D025 and D050	14
Wiring diagrams D088 and D200	15
Wiring diagrams water-cooled D025 and D050	16
Wiring diagrams water-cooled D088 and D200	17
Wine Guardian Dimensional Data	18
Wine Guardian Specifications sheet	19
Safety	20
Safety Message Conventions	20
Danger.....	20
Warning	20
Caution	20
Lockout/Tagout Procedure.....	21
Safety Considerations.....	21
Safety Hazards	21
Electrical Hazards.....	21
Electrical Shock Hazards	21
Hot Parts Hazards	21
Moving Parts Hazards.....	22
Equipment Safety Interlocks	22
Main Power Switch	22
Installation	24
Pre-installation Test	24
Air Flow Illustration.....	24

Planning the Installation	26
Addressing Items in the Planning Process	26
Performing a Pre-installation Check.....	26
Locating the Unit.....	26
Grilles	27
Reducing Noise from the Unit	27
Installing the Unit Outdoors.....	27
Mounting the Unit	28
Floor Mounting.....	28
Wall Mounting.....	28
Ceiling Mounting.....	28
Installing the Condensate Drain Connection	28
Installing the Drain Line	29
Priming the Drain Trap.....	29
Wiring the Unit for Power	29
Installing the Thermostat and Communication Cable	31
Mounting the Remote Interface Controller	31
Installation of the Wine Guardian Remote Sensor	33
Mounting the Remote Sensor	33
Joining Communication Cable	35
Changing Jumper Positions	35
Standard Controller Functions	36
Installing the Ductwork and Grilles	41
Location of Supply and Return Grilles.....	42
General Duct Recommendation.....	43
Using Ductwork.....	43
Cold Air to/from Wine Cellar.....	43
Warm Air to/from Condenser	43
Typical Mounting Arrangements	44
Duct Adapter Sizes	45
Ducting Options.....	45
Single Outlet Duct Installation.....	45
Inspection and Start-up Checklists	46
Receiving and Inspecting.....	46
Handling and Installing.....	46
Starting-up the Unit.....	46
Starting Up and Operating the Wine Guardian	47
Turn on the Unit.....	47
Testing the Fan.....	47
Running the Unit.....	47
Cycling the Unit.....	48
Setting the Thermostat.....	48
Regulating the Wine Cellar Temperature	48
Changing the Air Flow Direction.....	48
Maintenance	49

General.....	49
Cleaning the Filters.....	50
Cleaning the Condensate Drain System.....	50
Cleaning the Humidifier (optional).....	50
Heating Coil Option.....	50
Low Ambient Option.....	51
Maintenance Schedule	51
Monthly.....	51
Yearly	51
Troubleshooting.....	52
Typical Start-up Problems.....	52
Unit Does Not Start-up.....	52
Power Switch Light is Off.....	52
Power switch light is on and the thermostat light is off	52
Power switch light is on and the thermostat light is on	52
Unit is operating and blows evaporator air,.....	53
Problems Controlling Cellar Temperature	53
Cellar Temperature too cold (below 51°) when unit is running	53
Cellar Temperature is too cold (below 51°) when unit is not running	53
Problems Controlling Cellar Humidity.....	54
Humidity too low or supply air is too cold, without optional humidifier.....	54
Humidity too low, without optional humidifier.....	54
Humidity too low with optional humidifier.....	54
Humidity too high when unit is running but not cooling.....	54
Humidity too high when unit is not running.....	55
Humidity too high when unit is running and cooling.....	55
Other Miscellaneous Problems	55
Unit operates but the power switch light is not ON	55
Unit is leaking water.....	55
Unit is running properly, but the sound of the unit is objectionable.....	55
High Pressure Switch has Shut Down the Unit	56
Instructions to Reset High Pressure Switch	56
Advanced Troubleshooting.....	57
Evaporator coil is freezing.....	57
High pressure switch keeps tripping.....	57
Unit cycles on and off more than 8 times/hr	57
High pitched or loud rubbing noise, clanking or vibration	57
Replacing the blowers.....	57
Contact and Warranty Information.....	58
Contact Information.....	59
Warranty and Warranty Procedure.....	59

Directory of Terms

Ambient Air – The surrounding area outside the cellar such as a room, basement, garage or outdoors.

CFM – Cubic feet per minute. A unit of measurement for the amount of air handled by the fan.

Condensate / Condensation – The water formed out of the air when it is cooled below a certain temperature (called dew point). Often referred to as “sweating” on pipes and cold surfaces. This water collects at the bottom of the evaporator or cooling coil and drains out of the unit through the drain line.

Condenser (Heat Rejection) Section / Coil – The Condenser Section uses the compressor, condenser coil and fan to remove heat from the refrigerant to the ambient air *outside* the wine cellar. The word condenser refers to the condensation of the refrigerant from gas to liquid phase.

CSA/ETL – Canadian Standard Association/Electric Testing Laboratory

Exhaust Air – The air leaving the evaporator or condenser section of the Wine Guardian unit.

Evaporator (Cooling) Section / Coil – The Evaporator Section uses the cooling coil and the fan to remove heat from the air *inside* the wine cellar to the refrigerant, cooling the air and condensing moisture out of the air. The word evaporator refers to the evaporation of the refrigerant from liquid to gas phase in the coil. The Evaporator Section is connected to or inside the wine cellar.

Flexible Duct – Round ducts with steel reinforced plastic liners, a layer of insulation and an outer plastic layer used to convey the air from the unit to the cellar or ambient space.

Grille or Diffuser – Inlet or outlet plates to direct the airflow or protect the inside of the unit.

Heat Gain / Loss – The amount of cooling or heating expressed in watts transferred between the wine cellar and the ambient space. The Wine Guardian must offset this load.

Inlet Air – The air entering the evaporator and condenser sections of the Wine Guardian unit.

Inlet Air – The air returning from the wine room to the Wine Guardian fan coil.

I.D. – Inside diameter

NEC – National Electrical Code

O.D. – Outside diameter

Psig Pounds – Force per square inch gauge

NEC – National Electrical Code

Recovery – The amount of cooling the unit does to return the cellar to its set point temperature after some new load is introduced, such as people or new cases of warm wine entering the cellar.

Return Air - The air leaving the cellar and returning to the inlet of the evaporator coil.

SP – Static pressure. Unit of measurement (inches of water column) of the pressure of the air handled by the fan.

Set Point – The desired temperature or humidity set on the thermostat or humidistat.

Supply Air - The air entering the cellar from the discharge of the evaporator coil.

Illustrations

Overview of the Wine Guardian unit.....	12
Overview – vapor compression system	12
Overview – water-cooled system.....	13
Overview – vapor compression system	13
Wiring diagram of D025 and D050	14
Wiring diagram of D088 and D200	15
Wiring diagram of water-cooled D025 and D050	16
Wiring diagram of water-cooled D088 and D200	17
Wine Guardian dimensional data.....	18
Wine Guardian specifications sheet.....	19
Airflow illustration.....	24

Receiving, Inspecting and Unpacking the Wine Guardian Unit

Receiving and Inspecting the Unit

NOTE: Wine Guardian units are factory assembled and tested prior to shipment.

Wine Guardian units are shipped in individual corrugated boxes.

- ✓ Lift at the designated handhold locations only or fully support from underneath. A shipment may include one or more boxes containing accessories.
- ✓ Before opening the container, inspect the packing crates or boxes for obvious signs of damage or mishandling.
- ✓ Write any discrepancy or visual damage on the bill of lading before signing.
- ✓ Inspect all equipment for any sign of damage caused during transit.
- ✓ Report all visual or concealed damage to the carrier and file a claim immediately.
- ✓ Thoroughly inspect the contents for any visible damage or loose parts.

IMPORTANT

If this procedure is not followed, the shipping company may reject the claim and the consignee may suffer the loss. Do not return the shipment to the factory.

Review the Packing Slip to Verify

- ✓ Model number
- ✓ Factory installed options
- ✓ Unit accessories

If any items listed on the packing slip do not match your order information, contact the place of purchase immediately.

Check the unit for

- ✓ An electrical power cord
- ✓ A thermostat with communications cable plugged into side of unit
- ✓ A drain line coming out of the unit

General Description

Refer to overview illustrations starting on page 12

The Wine Guardian cooling unit is a professional grade, American manufactured, self-contained climate control unit designed specifically for the storage of wine at cellar temperatures. It is designed for easy installation and operation. Wine Guardian uses digital electronic controls and R-134a refrigerant. The entire unit is tested at the factory and shipped as a single package. All components are of a high quality, standard commercial grade. The entire unit is approved by ETL according to UL 1995 and CSA safety standards. All wiring complies with NEC. Each unit is furnished with a sealed, UL-approved power cord and plug.

The Wine Guardian unit is completely self-contained and includes either an integral air cooled or water-cooled condenser. The unit is functionally divided into two sections, the evaporator (or cooling section) and the condenser (or heat rejection section). Each section contains a coil to add or remove heat and a fan to move the air through the coil and into or out of the cellar or adjacent space. The Wine Guardian unit is designed to be used as a remotely mounted unit with external ductwork connections.

Air first passes through the cooling coil and is cooled by the refrigerant inside the coil. This causes any excess humidity in the air to condense and be captured in the drain pan and piped outside the unit. Air then enters the fan where it is pressurized and discharged out of the unit. Optional heating coils are located between the cooling coil and the fan. These coils heat the air to prevent low temperatures in the cellar. The thermostat, located in the cellar, turns on the cooling or heating as needed to maintain its setpoint. It does not allow the cooling and heating to be on at the same time.

The compressor and condenser sections are activated whenever the unit is cooling. The condenser fan draws air from the surrounding or ambient space either directly or through a duct. The air is first drawn through a filter to remove any airborne dust particles to keep the coil clean. The air flows through the condenser coil where it absorbs heat from the refrigerant in the coil. The air is then discharged out of the unit by the condenser fan.

The water-cooled Wine Guardian system requires cooling water to be piped to the unit for proper operation. The cooling water absorbs the refrigerant heat through the unit's water-cooled condenser coil. Warm water is then directed out of the unit back to the cooling water system or to a drain.

IMPORTANT

The air exhaust from the condenser fan on air-cooled units is hot and will be 25 to 35 degrees F above the entering temperature. This may cause overheating problems in the summer months, especially with high humidity. Exhaust the hot air to the outside. In the winter, this heated air can help to heat the surrounding space.

Standard Specifications

IMPORTANT

Design and specifications are subject to change without notice

The Wine Guardian Unit Contains

- ✓ A thermal expansion valve to control the flow of refrigerant into the evaporator coil
- ✓ A filter dryer to keep the refrigerant clean and free of contaminants
- ✓ A sight glass to observe the level of refrigerant
- ✓ A manual reset high pressure switch to protect the system from high pressures
- ✓ The unit uses only R-134a refrigerant
- ✓ A built-in condensate drain trap. (no external trap is required)

The Wine Guardian meets or exceeds its rated capacities for total BTU/H and CFM at design cellar conditions and external static pressures. Both the evaporator and condenser fans are capable of rated CFM against the external static pressure imposed by recommended ductwork. Both fans are motorized impeller plug fans, statically and dynamically balanced, and use permanently lubricated, direct drive motors that require no maintenance.

All exterior framing of the Wine Guardian is powder coated 0.063” gauge aluminum to prevent rust and corrosion. All coils are copper tubes with aluminum fins. The unit uses an external drain to remove excess moisture and not reintroduce it into the cellar or ambient space. Removable, multiple access doors are provided to facilitate cleaning and maintenance, duct connections, and access to components and wiring.

The condenser coils have pre-filters on the inlet to prevent dust and dirt from fouling the coils, thereby reducing capacity. Each unit has at least three discharge outlets on both the evaporator and the condenser coils to facilitate custom installations. Water-cooled units have copper straight tube connections for both cooling water inlet and outlet.

Each unit is provided with a pre-wired and tested electronic digital thermostat for remote mounting in the cellar. The thermostat has multiple control functions for the fans, cooling and heating. It has a fully automatic mode to switch between heating and cooling.

Compressors are rotary, self-lubricating, permanently sealed, hermetic reciprocating type compressors, with internal overload protection and capacitor start with a minimum of one-year manufacturer’s warranty and an optional five-year warranty. Compressors are mounted on rubber-in-shear isolators to reduce noise and vibration.

Electric power is supplied by a single factory furnished cord and plug. All external controls are digital and proprietary to Wine Guardian products. Only approved communication cable and Wine Guardian controllers are suitable for proper system operation.

Accessories and Optional Equipment

Heating Coils

An optional heating coil is built-in and requires no additional power source. The electric heating option is factory installed and includes primary and secondary over-temperature protection devices per UL and NEC.

Water Cooled Option

A water cooled option is available that uses a tube-in-tube heat exchanger in place of the condenser coil and fan. Waste heat from the refrigerant is transferred to the water. A two-way control valve is used to regulate the flow of water to maintain head pressure.

Duct Collars and Flexible Ducts

Ducting for the Wine Guardian is sold in kits by size for each unit. Each kit contains two adapter collars, one 25-foot length of round flexible duct and two straps. The number of duct kits needed depends on the layout. The size of the kit depends on the model Wine Guardian selected. Follow installation instructions carefully. Poorly or incorrectly installed ducts can degrade the performance of your unit dramatically.

Extended Compressor Warranty

The Wine Guardian uses only the best commercially available compressors on the market. However, since the compressor is the single most expensive component in the unit, it is recommended that you purchase the extended warranty option.

Low Ambient Option

A factory installed Low Ambient option is available that makes the Wine Guardian capable of exposure to low ambient temperatures. This feature controls the condenser fan operation based on head pressure and heats the oil reservoir. The Low Ambient Option (LAO) is recommended whenever the condenser section is exposed to air temperatures below 40 degrees F. This can occur if the unit is placed in a garage or under an outdoor canopy, or if the unit is located inside a heated space but the condenser air is ducted in from the outside.

Condensate Pump

An optional Wine Guardian automatic condensate pump is available to pump the water to a sink or outside. It requires a separate 120 volt electrical outlet.

Humidifier and Humidistat

Another popular option for the Wine Guardian is a humidifier. The humidifier is available as a freestanding unit powered by the Wine Guardian system, as freestanding unit with its own power cord and humidistat or as an integrated unit that bolts to the side of any Wine Guardian ducted system. The Wine Guardian humidifier requires a water supply and drain for operation.



**CAREFULLY FOLLOW THE INSTALLATIONS INSTRUCTIONS INCLUDED WITH THE HUMIDIFIER.
REFER TO THE INSTRUCTIONS CONTAINED IN THE BOX FOR THE HUMIDISTAT.**

High Ambient

A factory installed high ambient option is available (on D025 and D050 models only) that makes the Wine Guardian capable of exposure to high ambient temperatures. The high ambient feature consists of high output, fan condenser, and fan and coil. The high ambient option is recommended whenever the condenser section is exposed to air temperatures above 100 degrees F to a maximum of 120 degrees F.

Overview of the Wine Guardian Unit

Refer to overview illustrations starting on page 12

Cabinet – The cabinet and access doors are constructed of aluminum with a powder coated finish for corrosion protection and an attractive, maintenance-free appearance. Areas in contact with cold temperatures are lined with insulation to prevent condensation.

Condensing Section – Ambient air is circulated through the condenser section by a direct drive, permanently lubricated, motorized impeller blower. This section also contains the compressor and the electrical controls. If the water cooled option is purchased, a heat exchanger is used in place of the condenser coil and blower.

Evaporator Section – Cellar air is circulated through the evaporator section by another blower the same as above. The large evaporator coil face area eliminates condensate carry-over, reduces air pressure drop and optimizes heat transfer. A drain pan is located directly below the coil to capture condensate and is fabricated from aluminum to prevent rust and corrosion. The electric heating coil, if ordered, is factory installed between the evaporator coil and the blower, and is complete with contactor(s) and limit controls.

Electrical Controls – Most of the electrical components and controls are located in a separate area accessible on the side of the unit. All wiring is in accordance with the NEC. Wires are numbered and color coded to match the wiring diagrams.

Factory Tested – All Wine Guardian units are factory run-tested and checked for operational performance.

Filters – Nominal 1 inch thick filters are provided on both the evaporator and condenser inlets to protect the coils from dust and dirt. These filters are washable and reusable.

Humidity Option – The optional humidifier comes fully assembled and tested for field installation onto the Wine Guardian without any additional electrical power wiring. It automatically adds moisture into the cellar by the evaporation of water over a distribution pad. The same Wine Guardian thermostat controller supplied with the Wine Guardian unit automatically controls humidity as well as temperature.

Internal Drain Trap - Water condensate from the evaporator coil fills the trap and forms a seal to prevent air from being drawn back through the drain tube. This allows the drain pan to drain freely. No external trap is required.

Refrigerant Circuit – The factory charged circuit includes a thermal expansion valve with an external equalizer, sight glass with moisture indicator, a filter dryer, an automatic low pressure switch, and a manual reset high pressure switch. For the low ambient option, an automatic pressure switch controls the operation of the condenser blower and a heating element is added to the compressor oil reservoir. **See Fig 1 - Refrigeration Illustration on next page.**

Supply/return grilles – A powder-coated steel single direction grille is provided on the outlet of condenser section. One grille is provided on an outlet. The grille is interchangeable with access doors to control and direct the airflow. These grilles may be used in the room on the end of the ducts in ducted systems.

Overview Illustration of the Wine Guardian Unit

Fig. 1

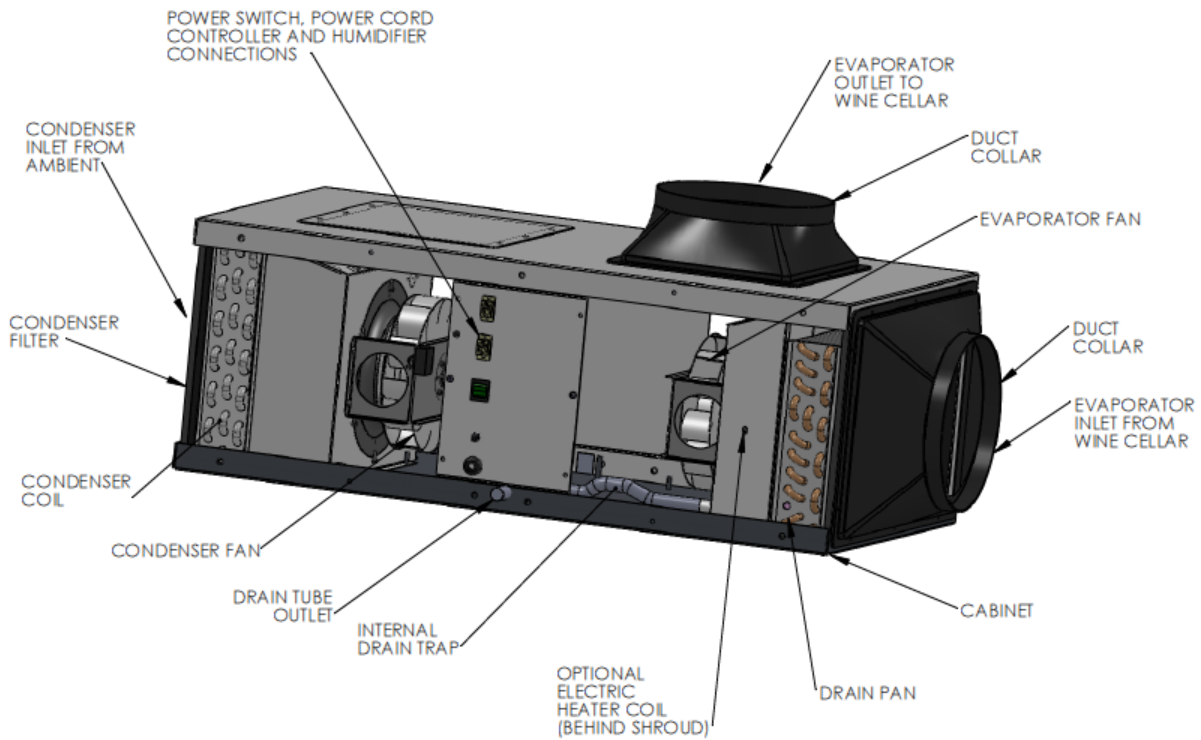

Overview Illustration - Vapor Compression System

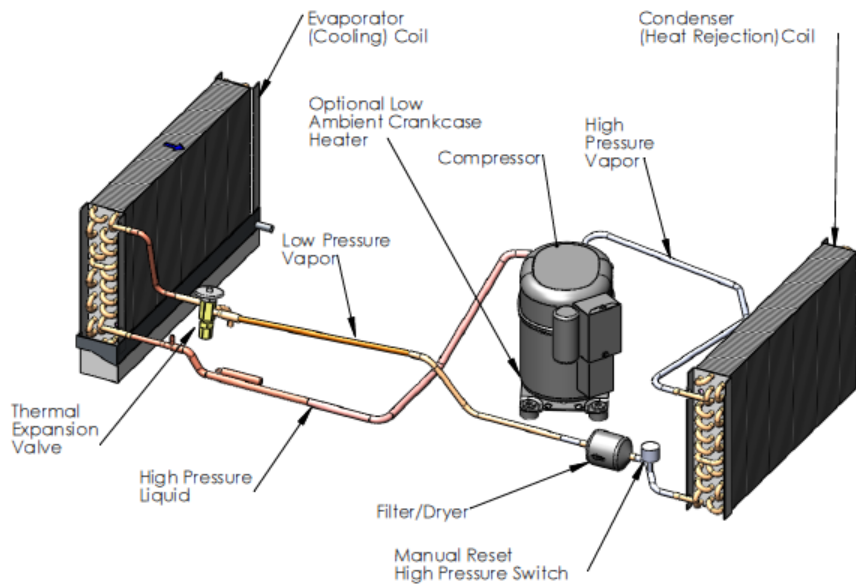
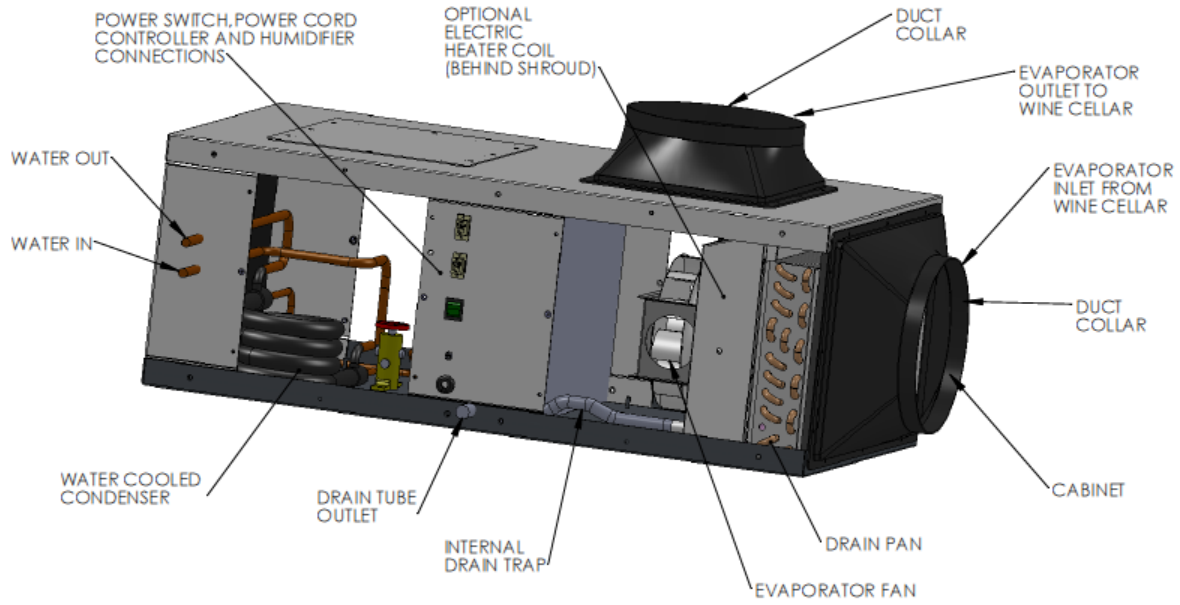

Fig. 2

Overview Illustration of water-cooled system

Fig. 3

Water In



Overview Illustration - Vapor Compression System

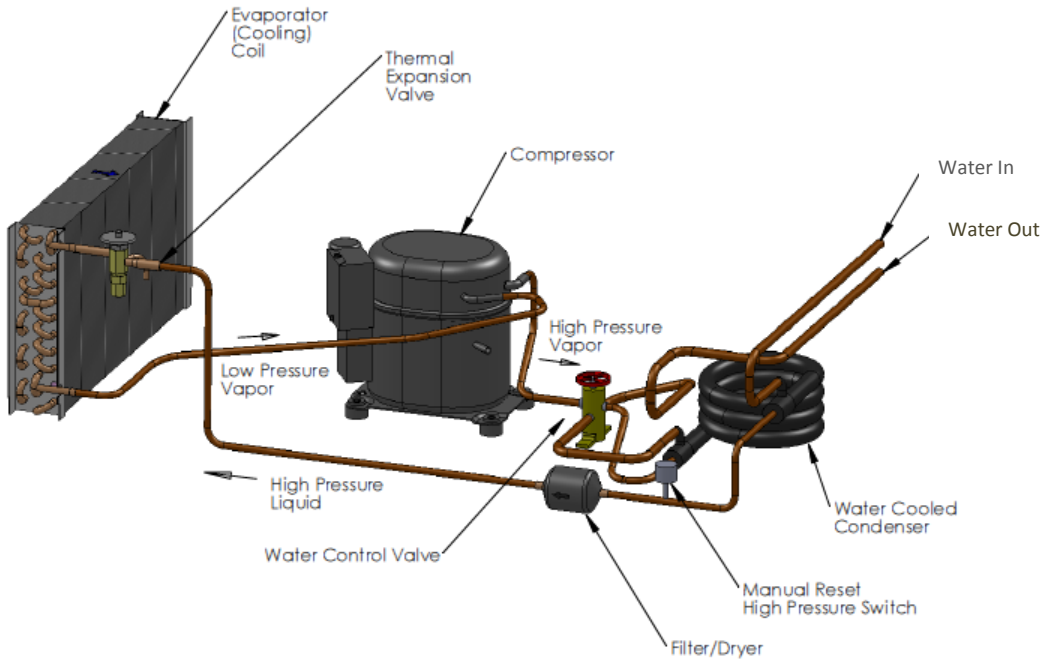

Fig. 4

Wiring diagrams D025 and D050

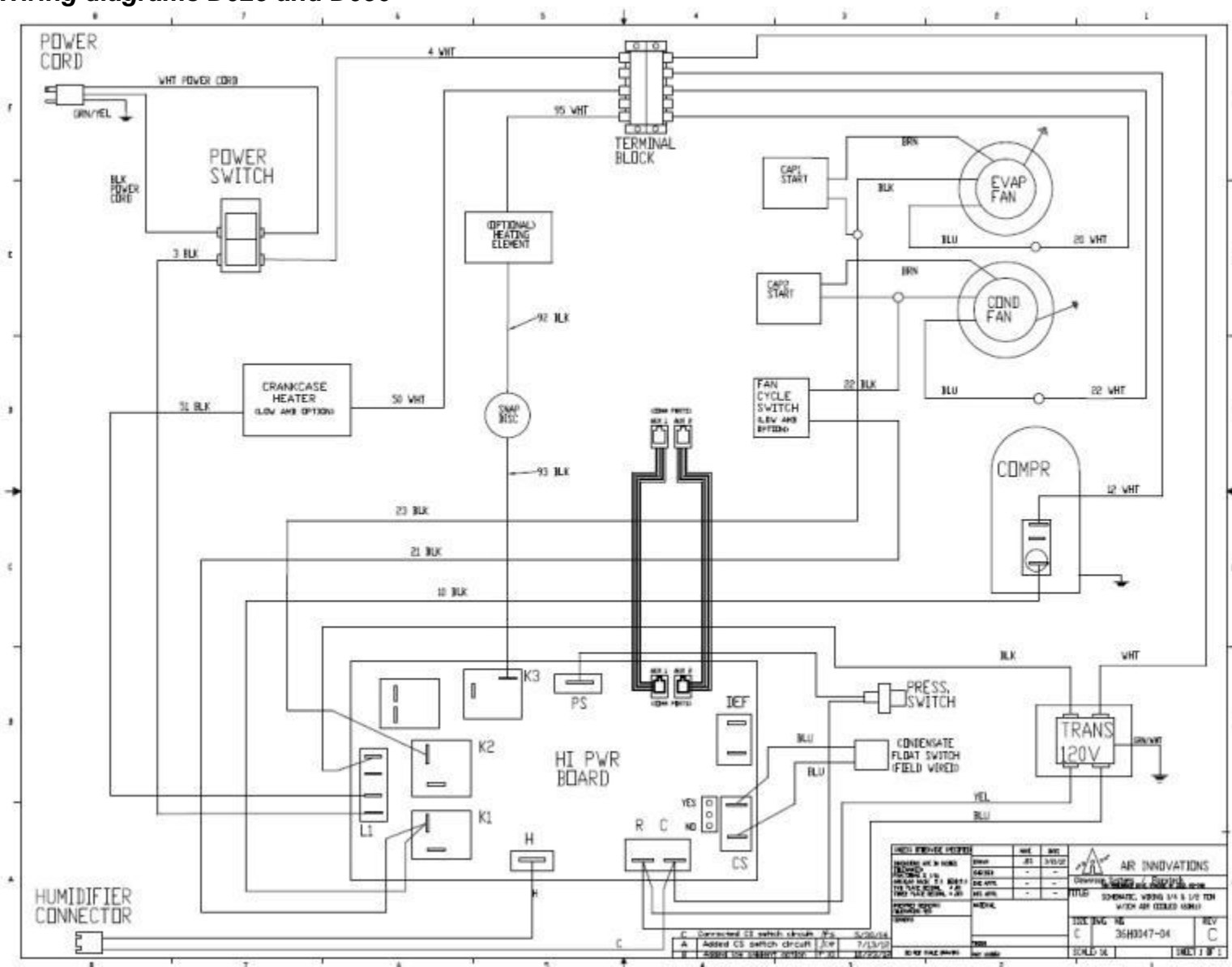

Fig.5

Wiring diagram D088 and D200

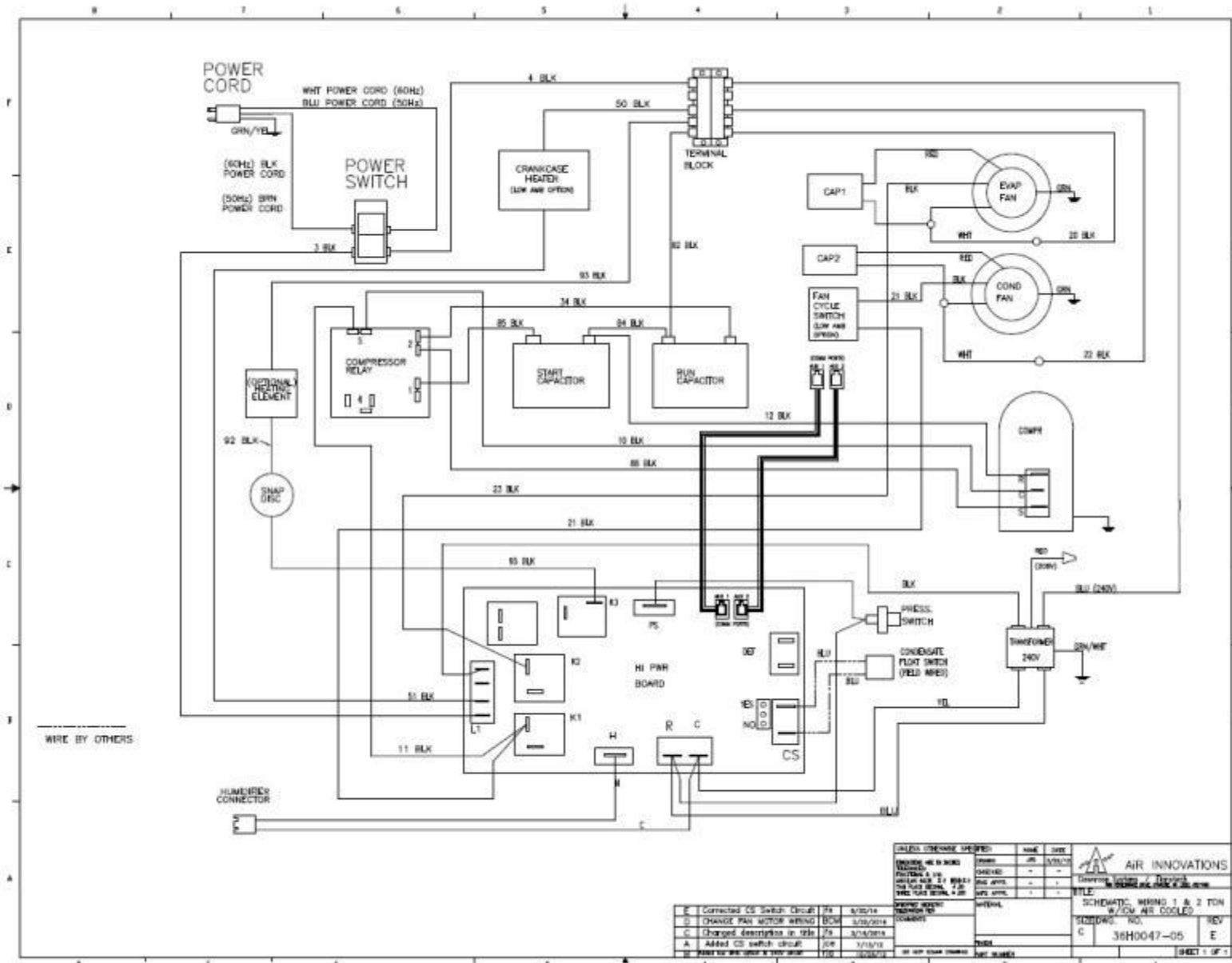

Fig.6

Wiring diagram water-cooled D025 and D050

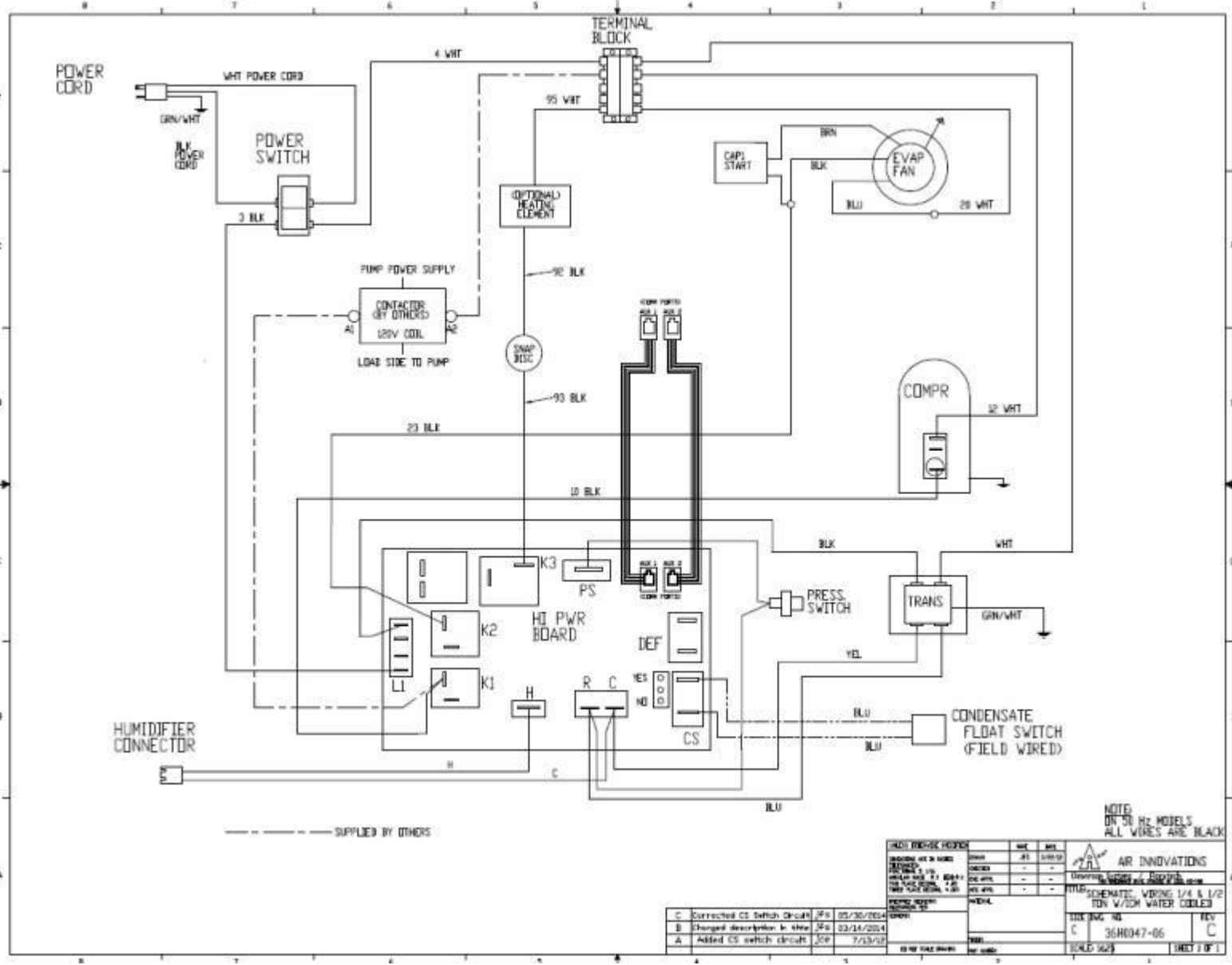

Fig.7

Wiring diagram water-cooled D088 and D200

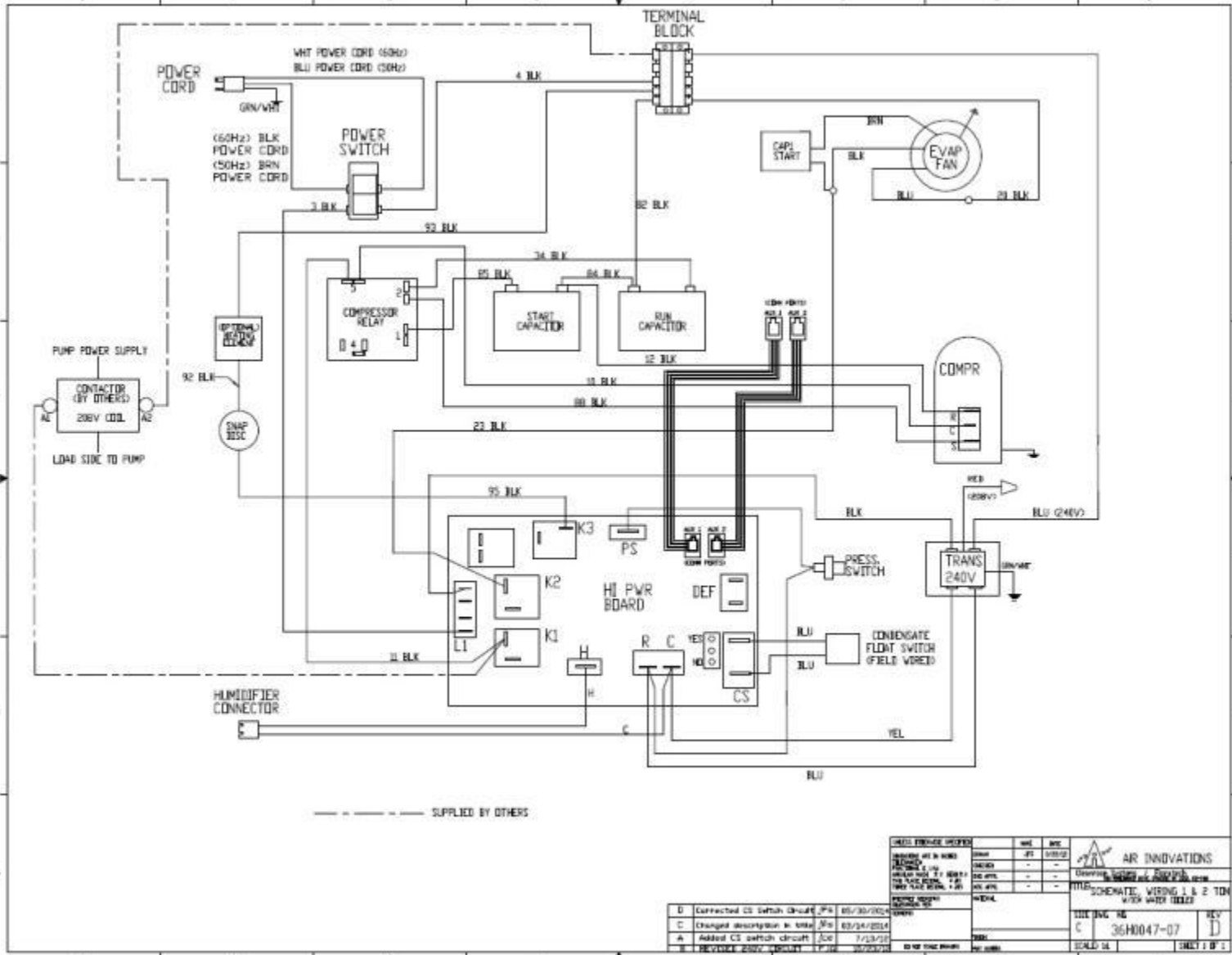

Fig. 8

Wine Guardian dimensional data

Fig. 9

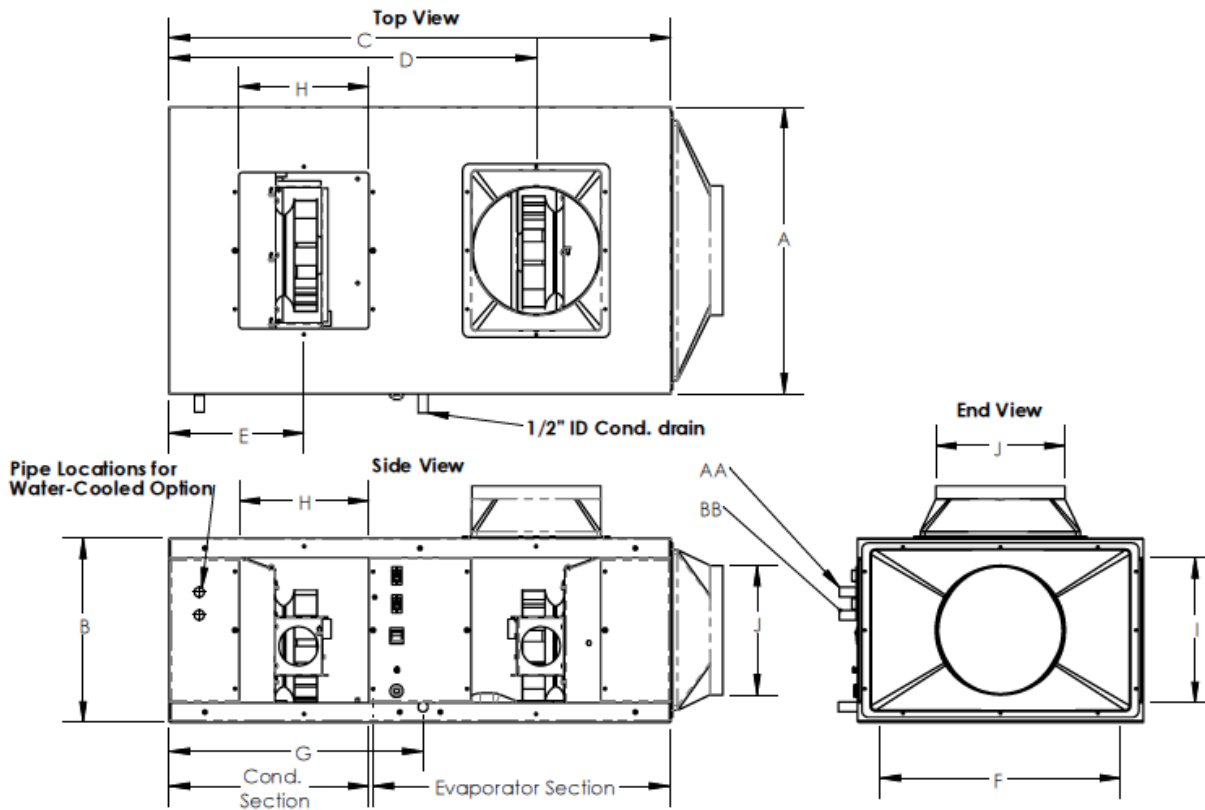



Table 1

Wine Guardian Dimensional Data

Model Number		D025	D050	D088	D200
Dimensions - Nominal - add 0.375" for each grille					
A – Depth	Inches	14	22	22	22.38
B – Height	Inches	14	14	14	18
C – Width	Inches	32.63	32.63	32.63	49.50
D – Evap. discharge location	Inches	23.38	23.38	23.38	37.19
E – Cond. discharge location	Inches	9.25	9.25	9.25	12.31
F – Inlet opening width	Inches	10	10	10	18.88
G – Drain outlet location	Inches	16.31	16.31	16.31	28.75
H – Discharge opening width	Inches	10	10	10	11.63
I – Inlet opening Height	Inches	12	12	12	15
J – Duct opening	Inches	8	10	10	12
AA – Water out (O.D)	Inches	0.625	0.625	0.625	0.625
BB – Water in (O.D)	Inches	0.625	0.625	0.625	0.625
Weight	lbs	80	125	130	200

Wine Guardian Specifications sheet

Fig.10

							
SPECIFICATIONS							
DUCTED SYSTEMS							
Model Number		D025	D050	D088		D200	
Power Requirements	volt/phase/Hz	115/1/60	115/1/60	208/1/60	230/1/60	208/1/60	230/1/60
Performance							
Nominal Compressor	HP	0.35	0.50	1	1	2.5	2.5
Net Cooling Capacity*		Total/Sensible	Total/Sensible	Total/Sensible	Total/Sensible	Total/Sensible	Total/Sensible
@60 Deg F condenser inlet air	BTUH	4520/9050	6920/4920	10700/7120	10830/7500	17570/12430	17880/12790
@70 Deg F condenser inlet air	BTUH	4300/2915	6570/4740	9900/6800	10250/7180	16580/11850	16720/12000
@80 Deg F condenser inlet air	BTUH	3760/2715	6320/4510	9420/6610	9600/6650	15350/11100	15680/11780
@90 Deg F condenser inlet air	BTUH	3540/2580	5980/4230	8900/6120	8780/6210	14000/10580	15000/10870
@110 Deg F condenser inlet air	BTUH	3260/2400	4985/3820	N/A	N/A	N/A	N/A
@120 Deg F condenser inlet air	BTUH	3000/2280	4585/3590	N/A	N/A	N/A	N/A
Controls							
Type		Digital electronic	Digital electronic	Digital electronic		Digital electronic	
Temperature Accuracy/RH% Accuracy		1F / 10%	1F / 10%	1F / 10%		1F / 10%	
Evaporator Section							
Fan Motor Size	Watts	75	100	175	195	180	180
Rated Air Flow (free blow)	CFM	245	300	435	485	780	810
Rated Air Flow @ pressure loss	CFM	200 @0.10" wc	320 @0.20" wc	370 @0.20" wc	440 @0.20" wc	710 @0.35" wc	745 @0.35" wc
Air-cooled Condenser Section							
Fan Motor Size	Watts	75	100	175	195	180	180
Rated Air Flow (free blow)	CFM	245	300	435	485	780	810
Rated Air Flow @ pressure loss	CFM	200 @0.10" wc	320 @0.20" wc	370 @0.20" wc	440 @0.20" wc	700 @0.35" wc	725 @0.35" wc
Water-cooled Condenser Section (option)							
Water usage at 40 Deg F rise	GMP	0.30	0.60	1.20		2.50	
Pressure drop	PSI	0.40	0.40	0.08		1.20	
Pipe connection size (in/out) O.D.	Inches	0.63	0.63	0.63		0.63	
Heat (Option)							
Type		Electric	Electric	Electric	Electric	Electric	Electric
Capacity	Watt/STUH	1000/3400	1000/3400	1835/5582	2000/6800	1835/5582	2000/6800
Humidifier (Option)							
Type		Removable drip pad with integral fan					
Capacity - water temp of 60 Deg F	lbs./hr	0.42					
Capacity - water temp of 90 Deg F	lbs./hr	0.97					
Capacity - water temp of 100 Deg F	lbs./hr	1.11					
Electrical Requirements							
Current Draw - Cooling mode	Amps	7.1	11.3	9.8	8.8	15.8	14.1
Current Draw - Heating mode	Amps	9.4	9.8	8.8	9.5	8.8	9.5
Minimum Circuit amps (heat / no heat)	Amps	11.8/8.8	11.8/13.7	10.7/11.8	11.7/10.8	10.7/10.1	11.7/17.2
Optional Low Ambient	Amps	0.4	0.4	0.2	0.2	0.2	0.2
Optional High Ambient	Amps	0.2	0	N/A	N/A	N/A	N/A
Optional Humidifier	Amps	0.4	0.4	0.4	0.4	0.4	0.4
Cabinet							
Construction		Aluminum					
Finish		Black - textured epoxy powder coat					
Weight	lbs.	80	125	130		200	
Dimensions (inches)	Width	33	33	33		50	
	Depth	14	22	22		22	
	Height	14	14	14		18	
Condensate Drain connection (ID)	inches	50"	50"	50"		50"	
		ETL UL 1995 / CSA C22.2		UL 1995 / CSA C22.2		UL 1995 / CSA C22.2	

1. Net cooling capacity at entering temperature and humidity conditions of 57 Deg F and 55% RH at rated airflow. Reduce capacity by 3% for each 10% reduction in evaporator airflow.

2. Wine Guardian reserves the right to make changes to this document without prior notice at its sole discretion.

3. All rating at sea level.

4. D200 air flow based on 0.35 inches Wine Guardian external static pressure using 50' of flexible ductwork, grille and coils. Rev. 7-2014

7000 Performance Drive | North Syracuse, New York 13212 USA
 800-825-3268 | 315-452-7400 | www.wineguardian.com | info@wineguardian.com
 Wine Guardian® is a registered trademark of Air Innovations

Safety

Before installing or maintaining the Wine Guardian unit do the following:

1. Read these instructions.
2. Keep these instructions.
3. Heed all warnings.
4. Follow all instructions.

IMPORTANT

The equipment described in this manual uses electricity. Be sure to follow the safety procedures outlined in the Wine Guardian Manual.

Safety Message Conventions

Safety messages contained in this manual, **DANGER**, **WARNING**, and **CAUTION** are bold and highlighted in red for quick identification.

Danger

A Danger message indicates an imminently hazardous situation which, if not avoided, results in death or serious injury. Messages identified by the word **DANGER** are used sparingly and only for those situations presenting the most serious hazards.

Following is a typical example of a Danger message as it could appear in the manual

 **DANGER** 
HIGH VOLTAGE - RISK OF SERIOUS INJURY OR DEATH
High voltages are present in the cabinets.
Before opening panels turn off all power.
Use the Lockout/Tagout procedure.

Warning

A Warning message indicates a potentially hazardous situation which, if not avoided, could result in death or serious injury.

Following is a typical example of a Warning message as it could appear in the manual:

 **WARNING** 
RISK OF PERSONAL INJURY OR DAMAGE TO EQUIPMENT
Modification to the equipment may cause injury.

Caution

A Caution message indicates a potentially hazardous situation which, if not avoided, could result in minor or moderate injury. It may also be used to alert against unsafe practice

Following is a typical example of a Caution message as it could appear in the manual:



Lockout/Tagout Procedure

1. Turn off the power switch (indicator light should be off)
2. Unplug the unit from the electrical outlet and cover the outlet to prevent accidentally plugging in the unit.

Safety Considerations

The equipment covered by this manual is designed for safe and reliable operation when installed and operated within its designed specifications. To avoid personal injury or damage to equipment or property when installing or operating this equipment, it is essential that qualified, experienced personnel perform these functions, using good judgment and safe practices. See the following cautionary statements.

Installation and maintenance of this equipment is to be performed only by qualified personnel who are familiar with local codes and regulations, and are experienced with this type of equipment.

Safety Hazards

Exposure to safety hazards is limited to maintenance personnel working in and around the unit. When performing maintenance, always use the Lockout/Tagout procedure, which is described in this chapter. Observe the maintenance safety guideline in the Wine Guardian Manual.

Electrical Hazards

Working on the equipment may involve exposure to dangerously high voltage. Make sure you are aware of the level of electrical hazard when working on the system. Observe all electrical warning labels on the unit.

Electrical Shock Hazards

All power must be disconnected prior to installation and servicing this equipment. More than one source of power may be present. Disconnect all power sources to avoid electrocution or shock injuries.

Hot Parts Hazards

Electric resistance heating elements must be disconnected prior to servicing. Electric heaters may start automatically, disconnect all power and control circuits prior to servicing the unit to avoid burns.

Moving Parts Hazards

The motor and blower must be disconnected prior to opening access panels. The motor can start automatically. Disconnect all power and control circuits prior to servicing to avoid serious injuries or possible dismemberment.

The fans are free-wheeling after the power is disconnected. Allow the fans to stop completely before servicing the unit to avoid cuts or dismemberment.

Rotating fan blades are present in the Wine Guardian unit. Sticking a hand into an exposed fan while under power could result in serious injury. Be sure to use the Lockout/Tagout procedure when working in this area or remove the power cord.

Equipment Safety Interlocks

There are no electrical safety lockouts installed within the unit. The power cord attached to the control box must be disconnected from the power sources prior to working on any part of the electrical system.

Main Power Switch

The main power switch is located on the side of the Wine Guardian unit. (See **Overview Illustration on page 12**) It shuts off the power to the unit.

Energy Type	Electrical
Hazard	Electrocution, electrical burns and shock
Magnitude	120 VAC and 230 VAC, 1 phase, 60 cycles
Control Method.....	Disconnect power cord and On/Off switch

- **Never** reach into a unit while the fan is running.
- **Never** open an access door to a fan while the fan is running.
- **Disconnect** the power cord switch before working on the unit. The unit may have more than one power source to disconnect.
- **Avoid** risk of fire or electric shock. **Do not** expose the unit to **rain** or **moisture**.



- **Check** weights to be sure that the rigging equipment can support and move the Wine Guardian unit safely. Note any specific rigging and installation instructions located in the Installation section of the Wine Guardian Manual.
- All supports for the unit **must** be capable of safely supporting the equipment’s weight and any additional live or dead loads encountered.
- All supports for the unit **must** be designed to meet applicable local codes and ordinances.

- **Do not** remove access panels until fan impellers have completely stopped. Pressure developed by moving impellers can cause excessive force against the access panels.
- Fan impellers continue to turn (free-wheel) after the power is shut off.



- **Clean** only with a dry cloth.
- **Never** pressurize equipment above specified test pressure. See Wine Guardian Specification Sheet
- **Do not use the Wine Guardian near water.**
- **Do not** block any supply or return air register or duct. Install in accordance with the instructions in the Wine Guardian Manual. Do not defeat the safety purpose of the polarized or grounding type plug. A polarized plug has two blades with one wider than the other. A grounding type plug has two blades and a third grounding prong. The wide blade or the third prong is provided for your safety. If the provided plug does not fit into your outlet, consult an electrician for replacement of the obsolete outlet.
- **Protect** the power cord from being walked on or pinched, particularly at the outlet plugs, convenience receptacles, and the point where it exits the unit.
- **Only** use attachments/accessories specified by the manufacturer.
- **Always** operate this equipment from a 120 VAC, 1 phase, and 60Hz power sources only.
- **Always** ground the outlet to provide adequate protection against voltage surges and built-up static charges.
- **Refer all** servicing to qualified service personnel. Servicing is required when the unit has been damaged in any way such as:
 - ✓ The power supply cord or plug is damaged.
 - ✓ Liquid has been spilled or objects have fallen into the unit.
 - ✓ The unit has been exposed to rain or moisture.
 - ✓ The unit does not operate normally.
 - ✓ The unit has been dropped.

Installation

 **WARNING** 
SHARP EDGES
RISK OF SERIOUS INJURY
SHARP EDGES ARE PRESENT INSIDE THE WINE GUARDIAN SYSTEM

Pre-installation Test

Test the system before installing it to check for non-visible shipping damage.

To test the system:

- ✓ Set the system on the floor or a sturdy level surface.
- ✓ Plug in the system.
- ✓ Press the on/off switch and check that the control illuminates. This indicates the system has power.
- ✓ **The built-in timer prevents short cycling and keeps the system from turning on right away.** The system comes on and runs as long as the temperature of the space is above the thermostat set point. After several minutes, cold air comes out of the system from the evaporator section side and hot air comes from the condenser section. Listen for any unusual noise or vibration.

Air Flow Illustration

Fig. 1

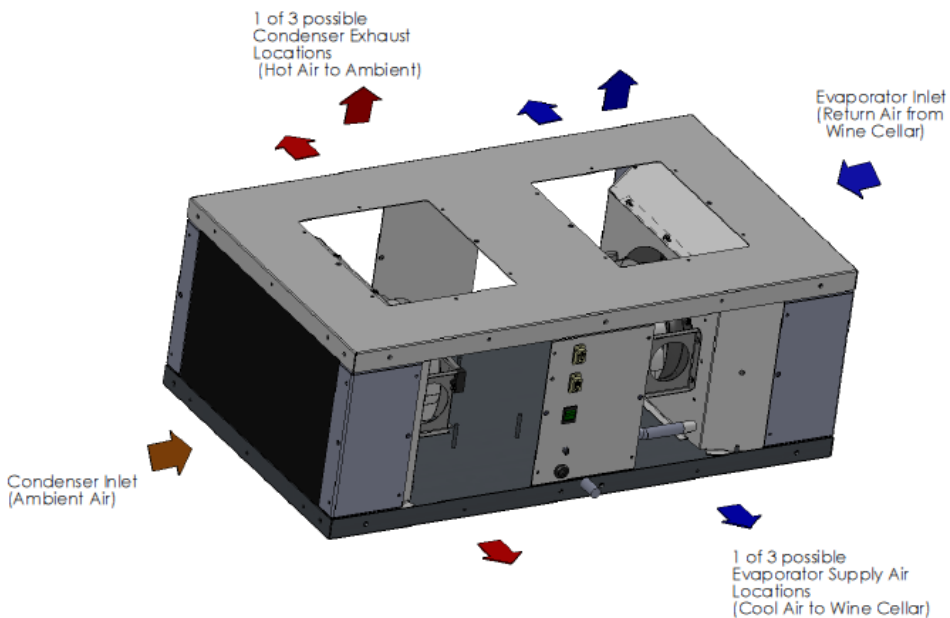



WARNING



RISK OF PERSONAL INJURY OR DAMAGE TO EQUIPMENT

Modification to the equipment may cause injury or damage to the equipment



DANGER



- ✓ **This equipment is heavy. Place the unit on the floor or on a level and stable surface that can support the full weight of the unit.**
- ✓ **Do not modify the equipment, it may cause damage to the equipment and will void the warranty.**
- ✓ **Never place anything on top of the unit.**
- ✓ **Never block or cover any of the openings or outlets to the unit.**
- ✓ **Never allow anything to rest on or roll over the power cord.**
- ✓ **Never place the unit where the power cord is subject to wear or abuse.**
- ✓ **Do not use extension cords.**
- ✓ **Never overload wall outlets.**
- ✓ **Do not remove or open any cover unless the unit is turned off and the power cord is unplugged.**
- ✓ **Use only dedicated power outlet boxes of the correct capacity and configuration for the unit model.**



CAUTION



RISK OF PERSONAL INJURY OR DAMAGE TO EQUIPMENT

Improper installation may result in the equipment malfunctioning and a safety hazard.

Read all of the installation instructions before installing the Wine Guardian unit

Planning the Installation

Addressing Items in the Planning Process

- ✓ Where to locate the unit? Should it be built into the wall or mounted remotely and ducted into the cellar?
- ✓ How to mount the unit?
- ✓ Decide where to locate the supply and return grilles in the room to achieve the temperature gradient and circulation preferred.
- ✓ Locate the electrical power outlet close to the unit, in cellar or out. **Do not use an extension cord!**
- ✓ Does the condenser heat exhaust need to be ducted away?
- ✓ Where to locate the thermostat?
- ✓ Where to run the drain line?
- ✓ Are all the parts here to complete the installation?

Performing a Pre-installation Check

- ✓ Check for the proper installation of the electrical plug configuration.
- ✓ Check for the properly sized breaker.
- ✓ Is the cellar built with adequate insulation and vapor barriers?
- ✓ Are ducts installed above the ceiling or in accessible places properly sized before being covered?
- ✓ Is enough space available around the unit for service and repair?

Locating the Unit

Wine Guardian units are typically installed indoors located near the cellar to minimize the duct runs. Each unit is provided with one entering or return air inlet and three possible supply air outlets for each of the evaporator and condenser sections. A maximum cumulative total length for both supply and return ducts (including bends) of 25 feet is recommended. If longer runs are needed use more than one supply opening to reduce the airflow in each duct by one half. **See Recommended Flexible Ductwork Sizing Chart on page 41.**

Provide a three foot clearance around the unit for removal of grilles or ductwork, access to filters and unit maintenance. If the humidifier is used, provide access space in front of it for service.

Grilles

One grille is provided on the condenser outlet. The grille is removable and can be replaced with a duct collar should warm air need to be ducted away from the mounting area. Additional grilles can be purchased as an option and as wall grilles inside the cellar. The return air, or inlet, to the unit must connect to the return air outlet from the cellar. Any of the three supply air outlets on the unit can be used for the ductwork to the supply grille inside the cellar. The factory installed supply duct can be relocated to any of the other two openings. The procedures below apply to both the evaporator and the condenser sections. In most cases, no ducts are installed on the condenser section because the unit is located in a mechanical or storage type space. If exhaust heat is undesirable, use duct collars and ductwork to move the heat outdoors or to another space.

Reducing Noise from the Unit

Consider noise when locating the unit close to the cellar or an adjacent occupied space. A piece of 1 inch or two inch dense rubber or Styrofoam with foil face in between the unit and the wall absorbs and reduces the noise from the unit. For air noise use larger grilles or use flexible ductwork to absorb the noise. Sound usually travels as a line of sight. Sound is reduced when it turns a corner, such as passing through a bend in ductwork. If the unit is supported from a wall or joist, using a rubber pad under the unit will reduce vibration transmission.

Installing the Unit Outdoors

The Wine Guardian is **NOT** designed nor approved for direct outdoor installation. If it is located outdoors, it **MUST** be protected with a rain-proof enclosure.

- ✓ Mount it above the ground on a solid, waterproof base to protect the unit from ground water.
- ✓ Do not locate it where grass clippings or leaves can blow into the unit.
- ✓ Keep the area around the unit clean and free of debris.
- ✓ Protect from damage when the unit is located in a garage or unheated shed. In both cases, the unit **MUST** have the low ambient controls built into the unit.
- ✓ Double insulating ducts with exterior grade insulation is recommended to keep the ducts dry and effective. Wine Guardian suggests installing one, sized flexible duct inside the next larger size duct where ductwork is exposed.
- ✓ Allow enough space at both ends of the unit to remove ductwork and allow access for service.

Mounting the Unit



RISK OF PERSONAL INJURY OR DAMAGE TO EQUIPMENT

**Check supporting structure for load bearing capacity to support the Wine Guardian.
All supports must be designed to meet applicable local codes and ordinances.
If in doubt, consult a qualified architect, engineer or contractor.**

NOTE: Review the mounting illustrations on page 43 before mounting the unit.

Floor Mounting

Mount the Wine Guardian on the floor but elevate it on frame with a plywood surface to keep it away from water. Allow adequate space for the external drain.

Wall Mounting

If the unit is mounted through the wall, adequately support it on both sides of the wall. Use floor or knee braces to transfer the load of the unit to the floor or wall.

Ceiling Mounting

Construct a structurally sound, level platform to place the unit on when hanging it from the ceiling joists. The Wine Guardian is NOT designed to be suspended from the top of the unit; it must be supported from the bottom. Place the unit on a platform to ensure that the unit is supported on all four corners. Leave adequate space on the top of the unit to remove the access doors for service.

In all cases the unit must be level to within plus or minus one-quarter inch end-to-end and plus or minus one-eighth inch side-to-side for proper operation. Locate the unit as close to the wine cellar as possible to reduce the length of the duct runs. If possible, use short and straight ducting on all ductwork. The addition of quarter-inch thick rubber pads helps prevent the transmission of vibration and noise.

Installing the Condensate Drain Connection

The Wine Guardian unit provides dehumidification for the inside of the wine cellar. It cools the air down to the dew point corresponding to the temperature set point of the thermostat. If the vapor barrier of the wine cellar is poorly constructed or excess moisture is in the basement, the unit has to remove excessive amounts of moisture from the wine cellar. The moisture appears in the condensate drain of the unit.

NOTE: If moisture becomes excessive, install a room type dehumidifier to dehumidify the basement so as to not overload your Wine Guardian.

Installing the Drain Line

- ✓ The drain line must extend from the unit to an external drain or disposal site. Do not use drain tubing any smaller than one-half inch inside dimension on the unit.
- ✓ Splice the drain extension onto the drain outlet with a sort piece of one-half inch copper tubing and secure with claps.
- ✓ If no drain is available, use a bucket. Do not extend the drain below the rim of the bucket. Empty the bucket periodically.

The Wine Guardian unit is provided with a built-in drain trap. The drain trap creates a water seal to prevent air from backing up into the drain pan and causing the drain pan to overflow. Do not create secondary traps in the external drain line.

Allow enough height for the drain line to function properly. If draining into a nearby sink, the unit must be elevated higher than the rim of the sink in order for the water to drain by gravity. Install with a one-quarter inch per linear foot of pitch. **Do not** tie the condensate drain line directly into the sanitary sewer system. See Accessories and Optional Equipment section for information about the condensate pump.

Priming the Drain Trap

The internal drain trap primes itself automatically once the unit has run for a period of time and after the unit cycles off. This is confirmed by water dripping from the drain.

Wiring the Unit for Power



**ELECTRICAL SHOCK HAZARD
RISK OF SERIOUS INJURY OR DEATH
The electrical outlet and wiring installation must meet the
national and local building codes.**

DO:

- ✓ Match the electrical wiring to the cord provided on the Wine Guardian.
- ✓ Provide dedicated circuit and wiring for the system.
- ✓ Match the wiring and breaker size to the rated load as shown on the serial plate and in this guide. See sample serial plate illustration on the following page.

Sample serial plate

Model#	D025				Serial#	XXXXXXXXXX	
Electrical	115/1/60					8.7	
Locked Rotor Amps	29		Humidifier Amps (opt.)				0.3
Compressor RLA	7.2		Crankcase Htr. Amps (opt.)				0.4
Condenser Fan Amps	0.7		Min. Circuit Amps (w/o opt.)				10.6
Evaporator Fan Amps	0.7		Refrigerant				R-134-A
Condensate Heater	N/A		System Charge				1lb. 3oz.
Total Unit Amps (w/o opt.)	8.6		Test Pressure				275psi
7000 Performance Drive, North Syracuse, New York 13212 Ph:800-535-3295 * 315-452-7400 * Fax: 315-452-7420							

DO NOT:

- ✓ DO NOT MODIFY THE PLUGS IN ANY WAY!
- ✓ Do not use extension cords.

IMPORTANT
The electrical power supply must be either 115 volt or 230 volt AC, 1 phase, 60 cycle, depending on the model of the unit, and cannot vary more than plus or minus 4% or damage may occur to the unit.

Plug the unit into the wall outlet. Gently pull on the plug to make sure it is tight.

Fig.1 Plug configurations

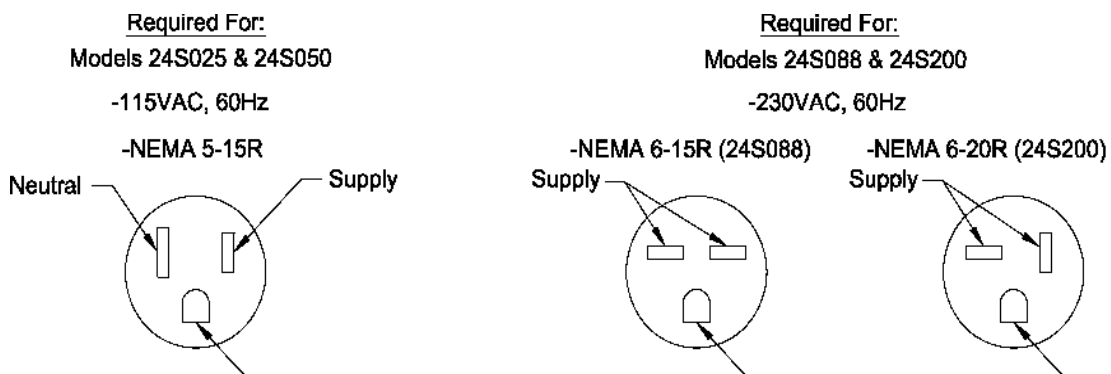

Installing the Thermostat and Communication Cable

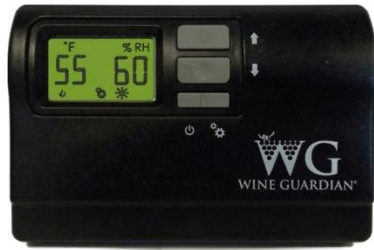

The Wine Guardian Remote Interface Controller is a combination temperature and humidity controller with single stage cooling, heating and humidifier control. Each Wine Guardian unit is supplied with a remote interface controller and 50 feet of communication cable. It is wired at the factory for testing prior to shipment.

In most applications the remote interface controller will be mounted within the wine cellar. The remote interface controller can also be mounted directly outside of the wine cellar or in any other room of the home or building. When mounted outside of the wine cellar, a remote sensor kit must be purchased and installed within the wine cellar. See below for remote sensor installation details.

***** The remote interface controller is now only available in black *****

IMPORTANT

Wine Guardian units are supplied with 50 feet of Cat 3, 6-wire twisted pair communication cable with RJ-11 connectors. Failure to use this type of communication cable WILL cause product damage and WILL void any equipment warranty.

Installation instructions should be followed CAREFULLY as improper splicing and/or joining of twisted pair cables can cause equipment failure.

Mounting the Remote Interface Controller



Fig. 1

1. Disconnect the communication cable from the side of the Wine Guardian unit and the remote interface controller.
 - a) Install the communication cable within the wall and/or ceiling structure of the wine cellar to the desired controller mounting location.
 - b) Mount the remote interface controller on a solid surface away from doors, corners, air outlets, drafts or heat generating equipment. Do not mount the remote interface controller directly on an outside wall or wall adjacent to a boiler room.



Fig. 2

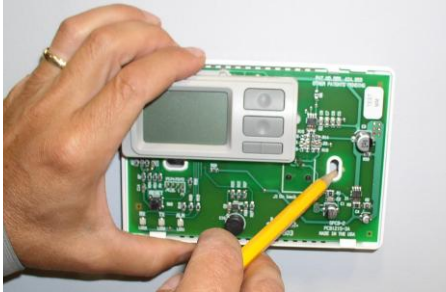

Fig. 3



Fig. 4



Fig. 5



Fig. 6

2. Remove the back plate of the controller and mark the mounting points at the desired location. (Fig. 2)

a) Mark the location of the communication cable connection as this area will require sufficient clearance for instance, a 1½ inch hole in the wall for flush mounting of the back plate. (Fig. 3)

3. Drill two one-eighth inch holes and insert anchors (provided within the mounting surface. Anchors may not be required if securing to a wall stud or racking system.

4. Plug in the communication cable to the back of the remote interface controller backing plate. (Fig.4)

a) Attach backing plate to wall using the two screws provided with the system. (Fig.5)

5. Re-install plastic face plate on to backing plate.

6. Re-attach the communication cable to the side of the Wine Guardian cooling unit. (Fig 6)

Installation of the Wine Guardian Remote Sensor



The remote sensor is a combination temperature and humidity sensor only. It is designed to be mounted within the wine cellar and can be used in combination with the remote interface controller or up to three additional remote sensors to read and control multiple areas within the wine cellar.

***** The remote sensor is now only available in black ******

Mounting the Remote Sensor



Fig.1



Fig.2

1. Disconnect the communication cable from the side of the Wine Guardian unit and the remote sensor. Install the communication cable within the wall and/or ceiling structure of the wine cellar to the desired controller mounting location.

IMPORTANT

A splitter device has been supplied within the remote sensor kit. The splitter device must be mounted at the Wine Guardian unit as shown. DO NOT mount the splitter device at the back of the remote interface controller or to the back of the remote sensor as this WILL cause component or system damage.

2. Mount the remote sensor on a solid surface away from doors, corners, air outlets, drafts or heat generating equipment. Do not mount the remote sensor directly on an outside wall or wall adjacent to a boiler room. Use a piece of foam insulation behind the sensor to insulate it from a hot or cold surface. The recommended height is four to five feet above the finished floor.
3. Remove the sensor cover plate by removing the two allen head screws at the top of the cover using the allen head wrench provided in the kit. (Fig.2) Mark the mounting points at the desired location within the wine cellar. Also mark the location of the communication cable connection as this area will require sufficient clearance, for instance 1½ inch hole in the wall for flush mounting of the sensor plate.

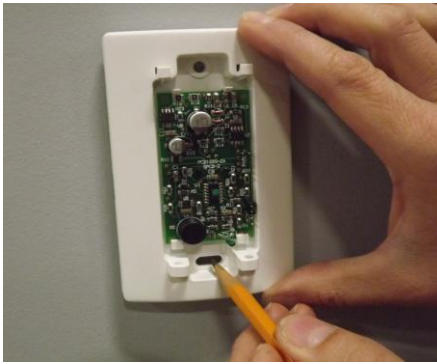

Fig. 3



Fig. 4



Fig. 5



Fig. 6

4. Drill two one-eighth inch holes and insert anchors (provided) within the mounting surface. Anchors may not be required if securing to a wall stud or racking system. (Fig.3)

5. Plug in the communication cable to the back of the remote sensor and attach to the wall using the two screws provided in the kit. (Fig.4)

6. Plug the remote sensor cables into the splitter device at the Wine Guardian unit along with the communication cable for the remote interface controller. (Fig.5)

NOTE: If using multiple remote sensors in one wine room continue to mount the remaining sensors before installation of the sensor cover plates. When multiple sensors are used the sensor jumper position must be adjusted in order for proper averaging of temperature and humidity readings. See page 35 for jumper set up.

Joining Communication Cable

IMPORTANT

Wine Guardian cooling systems are supplied with 50 feet of 6 wire, Cat 3 twisted pair communication cable with RJ11 type connectors. Caution must be taken when connecting two lengths of communication cable (splicing) to ensure uniform wire color before and after splice. An RJ11 Modular 6 wire STRAIGHT THROUGH type coupler is the ONLY coupler approved for splicing Wine Guardian twisted pair communication cable.

Changing Jumper Positions

(Averaging readings from remote sensor)



Jumper position 1



Jumper position 2



Jumper position 3

If using multiple remote temperature/humidity sensors in your application, refer to the photos showing the need to change the jumper locations internal to the control board on each remote sensor (up to three maximum).

For the control to average all of the sensors utilized (if more than one), the jumper must be in different positions on the pins.



As you can see, there are three pin settings. To access the jumper:

1. Remove the two-set screws holding on the plastic cover. This procedure allows the control to go to each remote sensor in sequence to average. Failure to perform this procedure will result in the system reading only one sensor and not the average of multiple sensors.

NOTE: If multiple sensors control the Wine Guardian unit, change factory default in configuration setting 10 to "averaging." You will need access code from Air Innovations service to use in configuration 8 to reach configuration 10.



Standard Controller Functions







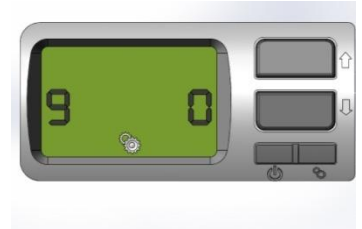



How to:		
<p>Turn system on/off</p>		<ul style="list-style-type: none"> • Press the “On/Off” button once. <p>Note: There is a five (5) minute time delay before the system turns on or turns off.</p> <p>*** Green LED lit when unit is on</p>
<p>Change temperature</p>		<ul style="list-style-type: none"> • Press the “Up” arrow once. The display will show the existing temperature setpoint. • Press the “up or down” arrow buttons to adjust the temperature to the desired setpoint.
<p>Change humidity</p>		<ul style="list-style-type: none"> • Press the “Up” arrow once. This display will show the existing temperature setpoint. • Press the “Settings” button once to display the “Humidity” setpoint. • Press the “Up” or “Down” arrows to adjust the humidity to the desired set point. <p>Note – a Wine Guardian humidifier must be installed and Setting 6 set to “1” or “2” before the controller will let you change percent humidity.</p>
		<ul style="list-style-type: none"> •

Settings – Press and hold the “Settings” button for five (5) seconds to access the following settings.







<p>Deg F or Deg C</p>		<p>Setting 1</p> <ul style="list-style-type: none"> • Press the “Down” arrow to change temperature from Deg F to Deg C. • Press the “Up” arrow to change temperature from Deg C to Deg F.
<p>Low temperature alarm setpoint</p>		<p>Setting 2</p> <ul style="list-style-type: none"> • Press “Settings” button to advance to Setting 2. • Press the “Up” or “Down” arrow buttons to adjust to the desired setpoint. Factory default is 50 Deg.F (10 Deg C).
<p>High temperature alarm setpoint</p>		<p>Setting 3</p> <ul style="list-style-type: none"> • Press “Settings” button to advance to Setting 3. • Press the “Up” or “Down” arrow buttons to adjust to the desired setpoint. Factory default is 65 Deg F (18 Deg C).
<p>Low humidity alarm set point</p>		<p>Setting 4</p> <ul style="list-style-type: none"> • Press “Settings” button to advance to Setting 4. • Press the “Up” or “Down” arrow buttons to adjust to the desired setpoint. Factory default is 5%.
<p>High humidity alarm setpoint</p>		<p>Setting 5</p> <ul style="list-style-type: none"> • Press “Settings” button to advance to Setting 5. • Press the up or down arrow buttons to adjust to the desired setpoint. Factory default is 95%.
<p>Add or remove humidifier</p>		<p>Setting 6</p> <ul style="list-style-type: none"> • Press “Settings” button to advance to Setting 6. • Press the “Up” or “Down” arrow buttons to adjust to the desired setpoint. Factory default is zero (0). <p>Zero (0) = No humidifier One (1) = Integral Wine Guardian mounted humidifier Two (2) = Stand-alone remote mounted humidifier</p>
<p>Fan AUTO or ON</p>		<p>Setting 7</p> <ul style="list-style-type: none"> • Press “Settings” button to advance to Setting 7. • Press the “Up” or “Down” arrow buttons to adjust number to the desired set point. Factory default is zero (0). <p>Zero (0) = Auto – fan only turns on when there is a call for cooling or heating One (1) = Fan On – fan remains on continuously</p>

<p>Advanced Settings--</p>		<p>Setting 8</p> <ul style="list-style-type: none"> • Press “Settings” button to advance to Setting 8. • Press the “up” or “down” arrow buttons to adjust number to the access code. Press “Settings” button to continue onto Setting 9 through 19.
<p>Compressor anti-short cycling time</p>		<p>Setting 9</p> <ul style="list-style-type: none"> • Press “Settings” button to advance to Setting 9. • Press the “Up” or “Down” arrow buttons to adjust to the desired time in one-minute increments. Maximum is 10 minutes, minimum is 0 minutes. <p>Compressor anti-short cycling time is the amount of allowable time between compressor stop and restart. Rapid start/stop of compressors can cause premature failure. Factory default is 5 minutes.</p> <p>WINE GUARDIAN DOES NOT RECOMMEND SETTINGS LOWER THAN FACTORY DEFAULT.</p>
<p>Set up remote sensor or thermostat</p>		<p>Setting 10</p> <ul style="list-style-type: none"> • Press “Settings” button to advance to Setting 10. • Press the “Up” or “Down” arrow buttons to adjust to the desired setting. <p>rS = Remote sensor rI = Remote interface LI= Local interface – Through-the-wall unit only A = Averaging – Jumper position within sensors must be adjusted. See page 35.</p>
<p>Enable or disable defrost sensor input</p>		<p>Setting 11</p> <ul style="list-style-type: none"> • Press "Settings" button to advance to Setting 11. • Press the “Up” or “Down” arrow buttons to adjust to the desired setpoint • 1 will equal enabled and a 0 (zero) will equal disabled.

<p>Defrost cut in temperature</p>		<p>Setting 12</p> <ul style="list-style-type: none"> • Press "Settings" button to advance to Setting 12. • Press the "Up" or "Down" arrow buttons to adjust to the desired setpoint • This setting will be adjustable from 25 Deg F to 40 Deg F (4 Deg C - 5 Deg C). Default will be 35 Deg F (2 Deg C). • There must be at least a 1 Deg F/C difference between defrost cut in and cut out set points.
<p>Defrost cut out temperature.</p>		<p>Setting 13</p> <ul style="list-style-type: none"> • Press "Settings" button to advance to Setting 13. • Press the "Up" or "Down" arrow buttons to adjust to the desired setpoint. • This setting will be adjustable from 35 Def F to 50 Deg F (2 Deg C - 10 Deg C). Default will be 40 Deg F (5 Deg C). • There must be a least a 1 Deg F/C difference between defrost cut in and cut out set points. <p>Note: This setpoint must be 1 Deg F/C higher than setting 12.</p> <p>Note: If C is selected and then switched back to F the default cut out will change to 41 Deg F.</p>
<p>Compressor run time setting for defrost.</p>		<p>Setting 14</p> <ul style="list-style-type: none"> • Press "Settings" button to advance to Setting 14. • Press the "Up" or "Down" arrow buttons to adjust to the desired setpoint. • The setting for compressor run time can be adjustable from 1 to 12 hours in 1 hour increments. Default will be 1 hour.
<p>Room sensor calibration</p>		<p>Setting 15</p> <ul style="list-style-type: none"> • Press "Settings" button to advance to Setting 15. • Press the "Up" or "Down" buttons to adjust to the desired set point. Maximum setting is +5 Deg F, minimum setting is -5 Deg F. Factory default is zero (0). Sensor calibration setpoint changes the actual display reading (temperature only) by the value of this setting. <p>Example: Sensor reading = 55 Deg F Setting 15 set to +4 Display reading = 59 Deg F</p>

RH% Sensor Calibration		Setting 16 This setting will allow the adjustment of RH% reading by +/-10%. Factory default is 0%RH.
Differential temperature adjustment		Setting 17 <ul style="list-style-type: none"> Press “Settings” button to advance to Setting 17 Press the “Up” or “Down” buttons to adjust to the desired setpoint. This setting changes the system/compressor; turn on temperature above setpoint. Factory default is set to 1 Deg F. Example: Sensor reading = 55 Deg F Setting 17 Set to +3 Deg F System/compressor turns on at 58 Deg F.
Deadband setting		Setting 18 <ul style="list-style-type: none"> Press “Settings” button to advance to Setting 17. Press the “Up” or “Down” buttons to adjust to the desired setpoint. This setting is the minimal allowable temperature difference between heating and cooling setpoints. Maximum is 5 Deg F, minimum is 1 Deg F. Factory default is set to 2 Deg F
Test mode setting		Setting 19 <ul style="list-style-type: none"> Press “Settings” button to advance to Setting 7. Press the “Up” or “Down” buttons to adjust to the desired setpoint. When set to one the controller will automatically turn on all outputs with the exception of electric heat. Factory default is zero. Zero (0) = Off. One (1) = On
System Selection		Setting 20 <ul style="list-style-type: none"> DO NOT CHANGE

Alarm Codes

<p>High temperature alarm Flashing temperature number</p>		<p>Press the "Up" or "Down" arrow once to change screen from alarm to normal temperature and humidity indication. "Flashing temperature number" along with flashing (!) symbol will remain on screen until temperature falls below the High Temperature Alarm set point (Setting 3).</p>
<p>Low temperature alarm Flashing temperature number</p>		<p>Press the "Up" or "Down" arrow once to change screen from alarm to normal Temperature and humidity indication. "Flashing temperature number" along with flashing (!) symbol will remain on screen until temperature rises above the Low Temperature Alarm set point (Setting 2).</p>
<p>High humidity alarm Flashing humidity number</p>		<p>Press the "Up" or "Down" arrow once to change screen from alarm to normal Temperature and Humidity indication. "Flashing humidity number" along with flashing (!) symbol will remain on screen until humidity falls below the High Humidity Alarm setpoint (Setting 5).</p>
<p>Low humidity alarm Flashing humidity number</p>		<p>Press the "Up" or "Down" arrow once to change screen from alarm to normal Temperature and Humidity indication. "Flashing humidity number" along with flashing (!) symbol will remain on screen until humidity rises above the Low Humidity Alarm set point (Setting 4).</p>
<p>!1 = High Pressure Switch Fault</p>		<p>THIS ALARM FORCES THE SYSTEM TO SHUT DOWN</p> <ul style="list-style-type: none"> This alarm forces the system to shut down <p>Press the "Up" or "Down" arrow once to change screen from alarm to normal Temperature and Humidity indication.</p> <p>"!1" will remain on screen until the High Pressure reset switch has been reset. See the trouble shooting guide page 55 for "Instructions to Reset High Pressure Switch"</p>
<p>!2 = CS (Condensate Switch Fault)</p>		<p>THIS ALARM FORCES THE SYSTEM TO SHUT DOWN</p> <ul style="list-style-type: none"> This alarm forces the system to shut down <p>Press the "Up" or "Down" arrow once to change screen from alarm to normal Temperature and Humidity indication.</p> <p>"!2" will remain on screen until the CS (condensate switch) fault is resolved and reset</p>

Installing the Ductwork and Grilles

Use ductwork to connect the unit to the supply and return outlets in the wine cellar. Use only insulated ductwork to minimize cooling losses, prevent sweating, and to reduce noise.

Use ductwork on the condenser section to redirect or absorb sound, to bring in outside air to the unit inlet, and/or to exhaust the hot air out of the ambient space.

NOTE: Do not exceed a total of 25 feet for each length of ductwork run.

Recommended Insulated Flexible Ductwork Sizing Chart						
Evaporator (cooling) Coil				Condenser (heat rejection) Coil		
Model#		Inlet (Return Air) Single	Outlet (supply air) Double		Inlet Single	Outlet Double
D025	8"	8"	6"	8"	8"	6"
D050	10"	10"	8"	10"	10"	8"
D088	10"	10"	8"	10"	10"	8"
D200	12"	12"	10"	12"	12"	10"

Notes: 1. The above referenced sizes are internal diameter in inches.
2. If a single supply is used out of the unit but then splits into two ducts, the size above that is recommended for double is used after the split.



CAUTION

RISK OF DAMAGE TO EQUIPMENT

Avoid crimping the flexible ducts. This chokes down the inside area and reduces the airflow causing the unit to operate erratically.

Be sure all ducts and surface in contact with the airflow are insulated and have a vapor barrier on the outside surface.

NOTE: Uninsulated ducts and surfaces cause bare exposed metal surfaces to sweat, further degradation of the insulation and a loss of equipment cooling capacity.

Location of Supply and Return Grilles

Locate the supply and return grilles inside the cellar to create an airflow pattern that maximizes air circulation in the room. Avoid short circulating of the air.

Do Not:

- Install the return air grilles directly on the floor as the grilles will collect dust from the floor.
- Locate the supply or return air grille where it is blocked by bottles, boxes or cases.
- Locate the supply air grille where it blows directly on the thermostat.

Relocating a grille on the Wine Guardian

- 1) Remove the fasteners from the grille.
- 2) Remove the fasteners from the access door panel to be replaced by the grille.
- 3) Relocate the outlet grille to its new location and secure in place using its fasteners.
- 4) Replace the access door panel where grille was located.

General Duct Recommendation

- ✓ Support the flexible duct often to prevent sags or bends.
- ✓ Stretch the duct to make for a smoother interior with less air resistance.
- ✓ For a 90-degree bend, insert a metal elbow inside the flexible duct to avoid crimping.
- ✓ Do not squeeze or reduce the inside diameter of the ducts. This restricts the airflow.
- ✓ Use short and straight ductwork.
- ✓ Review the configuration schematic on the Overview Sketch on page 12 for information about which panels are available for duct connections and service.
- ✓ Remove the panels or grilles from the openings to connect the ductwork.
- ✓ Check that all the fan blades move freely.
- ✓ Check for loose foreign objects in any of the air paths.
- ✓ Connect the round flexible ducts to the Wine Guardian using the duct collars that are provided with the duct accessory kit.
- ✓ Pull the outer plastic wrapping and insulation away from the end of the duct to expose the reinforced inside duct liner.
- ✓ Use tie straps of clamp around the **inside liner** to fasten the duct collar.

Do not clamp around the outside insulation. It compresses and loosens over time.

- ✓ Secure the duct collar to the unit using the screws provided. Be careful not to damage or bend the gasket.

Using Ductwork

Cold Air to/from Wine Cellar

- ✓ Connect the supply air ductwork from the cellar to the supply air duct collar at the Wine Guardian unit.
- ✓ Connect the return air ductwork from the cellar to the return air duct collar at the Wine Guardian unit.

Warm Air to/from Condenser

- ✓ Connect ductwork on the condenser to direct heat and the air noise away from occupants.
- ✓ Connect ductwork to another space within the basement or to the outdoors if the heat being exhausted is undesirable.

Typical Mounting Arrangements

The following illustrations are suggested mounting arrangements. These illustrations are not intended to be complete and detailed installation drawings. For questions or help regarding installation, call customer service at 1-315-452-7400, toll free 800-825-3268, fax 1-315-452-7420 or email info@wineguardian.com a sketch of the proposed area where the unit is to be installed

Remote Mount on Floor

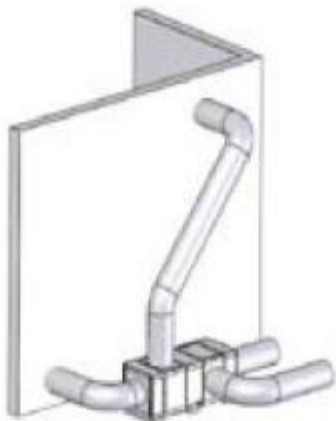

*Condenser inlet and
exhaust – to outside*

Ceiling Mounts

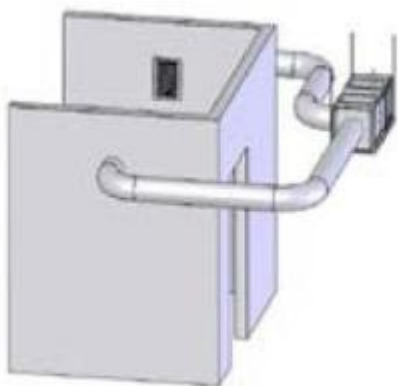

Outside Remote Mount

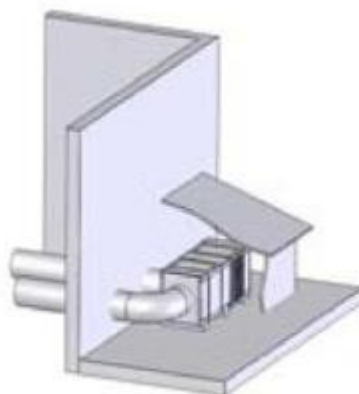

Duct Adapter Sizes

Table

MODEL	LOCATION	ROUND	OPENING SIZE		FLANGE	SIZE
		DUCT SIZE	WIDTH	HEIGHT	WIDTH	HEIGHT
D025	INLET	7.938	10.500	11.125	11.625	13.625
D025	OUTLET	7.938	10.000	11.125	11.625	13.625
D050,D088	INLET	9.938	18.500	11.125	21.625	13.625
D050,D088	OUTLET	9.938	10.000	11.125	11.625	13.625
D088	DUAL OUTLET	7.938	10.000	11.125	11.625	13.625
D0200	INLET	11.938	18.875	14.983	21.625	17.625
D0200	OUTLET	11.928	11.625	14.983	13.625	17.625
D0200	DUAL OUTLET	9.938	11.625	14.983	13.625	17.625

Dimensions in inches

Ducting Options

Single Outlet Duct Installation

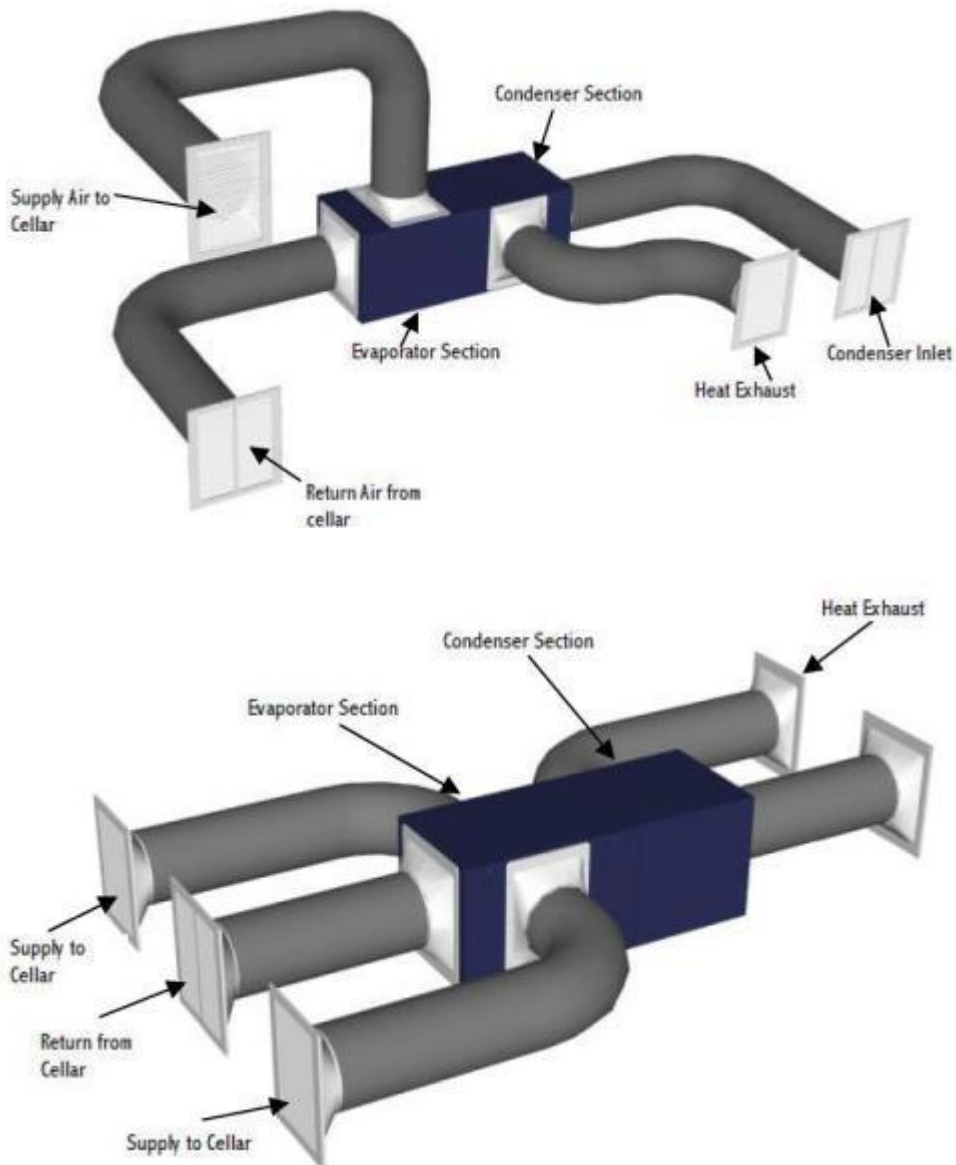

Inspection and Start-up Checklists

Receiving and Inspecting

- Unit received undamaged
- Unit received complete as ordered including accessories

Handling and Installing

- Unit mounted on solid level surface
- Sufficient space allowed for access to unit and accessories. Proper electrical service provided
- Hot water provided to humidifier
- Drain lines and trap installed properly
- Ductwork, fittings and grilles installed properly
- All cold duct surfaces insulated
- Low ambient control included if freezing condition present. No obstructions to air flow to condenser

Starting-up the Unit

- General visual inspection looks good. All wiring connections checked
- All ducts, grilles and panels in place
- Start unit
- Check ducts and connections for air leaks
- Balance air distribution
- Confirm condenser airflow is unrestricted
- Verify cooling and heating operation
- Check for excessive noise or vibration

Starting Up and Operating the Wine Guardian

Now that the installation is complete, it's time to start the unit up. Check to make sure all ductwork and electrical connections are secure.

Replace all panels that were removed during installation. Check that all of the openings in the unit are covered with a blank a panel, ductwork connection or a grille.



RISK OF PERSONAL INJURY

Cover all openings of the unit to prevent a hand or finger from access inside the unit.

Turn on the Unit

Plug in the unit. Turn-on the rocker switch on the side of the unit. The rocker switch lights up to indicate power to the unit. The unit may not come on right away due to the timer built into the circuiting to prevent short-cycling.

Testing the Fan

(Configuration Setting 7)

Factory default is “AUTO” fan operation. To change the fan setting refer to page 37 of this manual

- Power is on and the control circuit is energized and operating.
- AUTO means the fan runs only when the thermostat is calling for cooling, heating, or the optional humidistat is calling for humidification.

Running the Unit

- ✓ Check unit to confirm the compressor is running, such as the hum of the compressor or cool air leaving the unit.
- ✓ Check for any unusual noise or vibration, such as clanking or rubbing.

Initially, the unit may run continuously for several hours, up to a day or more, while it lowers the cellar temperature. Once the unit reaches the set point temperature, it shuts off and starts to cycle on and off as it continues to lower the bottle temperature to the set point. The cellar air reaches set point before the bottles. If the cellar temperature started at 75 degrees F, the supply air temperature discharged from the unit will probably be 15 degrees F to 20 degrees F colder. As the cellar temperature decrease to 55 degrees F, the supply temperature differential decreases 8 to 12 degrees F colder.

NOTE: The remote interface controller will show a “Hi Temp” fault until the wine cellar temperature falls below 65 deg. F. See page 40 for Hi Temp Alarm details.

Cycling the Unit

The fans continue to free-wheel for several minutes when the unit cycles off. This is normal. If the unit is furnished with a low ambient control, the condenser fan also cycles on and off during cooling. This maintains the head pressure on the compressor under low ambient conditions, and is normal. The bottom of the compressor stays warm even when the unit is off to keep the lubricating oil warm and separated from the refrigerant.

Setting the Thermostat

Normal settings are between 54 and 58 degrees F. If the optional heating coil is furnished, enter a separate temperature setting to maintain the lower setting. To prevent the unit from short cycling, the setting between heating and cooling cannot be closer than 3 degrees F.

Regulating the Wine Cellar Temperature

Wine cellars have a natural temperature gradient of approximately 5 to 10 degrees F between floor and ceiling. To increase or decrease the temperature in various zones, change the air flow patterns.

To keep the entire wine cellar at the same temperature, set the thermostat to run the supply fan continuously and not just when the cooling is operating. Set Fan switch to ON instead of AUTO.

NOTE: To monitor the cellar temperature, place thermometers in various locations in the cellar to monitor the temperature zones. Change the temperature in various zones by shifting the air flow patterns.

Changing the Air Flow Direction

The grilles furnished with Wine Guardian are single directional. Rotate the grilles to change the direction of the air flow.

When using multiple supply ductwork, balance the air flow between the ductwork. If too much air flows through one duct but not enough air flows from the other duct, install a damper or other restriction into the duct with too much air. That will force more air to flow out the other duct.

Maintenance

General



BEFORE PERFORMING MAINTENANCE ON THE UNIT, READ AND UNDERSTAND THE SAFETY INFORMATION CONTAINED WITHIN THE SAFETY CHAPTER OF THE WINE GUARDIAN MANUAL.



HIGH VOLTAGE - RISK OF SERIOUS INJURY OR DEATH
High voltages are present in the cabinets. Turn off all power. Use the Lockout/Tagout procedure before opening panels.



SHARP EDGES
RISK OF SERIOUS INJURY

Sharp edges are present on the fan wheels, housing, fins and coils.

Maintenance on Wine Guardian units requires working with high voltage and sheet metal with possible sharp edges. Only qualified personnel should perform maintenance. Some tasks require knowledge of mechanical and electrical methods. Make sure you are familiar with all hazards, general safety related procedures, and safety labels on the unit.



EXPOSURE TO MICROBIAL GROWTH (MOLD) CAN CAUSE SERIOUS HEALTH PROBLEMS

Standing water in drain pans promote microbial growth (mold) that cause unpleasant odors and serious health-related indoor air quality problems. If mold is found, remove it immediately and sanitize that portion of the unit.

The Wine Guardian is designed for minimal maintenance. The refrigerant system is hermetically sealed and requires no maintenance. The fans are permanently lubricated and require no maintenance. Some maintenance to the unit may be required due to dust or dirt in the air stream.

Cleaning the Filters

The condenser coil is provided with a reusable, washable air filter. The filter protects the coil from becoming coated or plugged by dust. Frequency of cleaning the filters is based on the amount of dust or dirt generated in the cellar or basement.

1. Remove the duct collar on the inlet end of the unit. (Optional)
2. Remove the filter covering the face the coil.
3. Wash it under warm water.
4. Shake off excess water.
5. Inspect and clean the face of the coil.



SHARP EDGES RISK OF SERIOUS INJURY
Sharp edges are present on the fins and coils.

6. Reinstall the filter.
7. Replace the duct collar.

Cleaning the Condensate Drain System

The condensate drain system traps dust and dirt. Clean the drain system once a year.

1. Shut off the rocker switch and unplug the unit.
2. Remove the grille or duct on the evaporator inlet.
3. Remove the filter and inspect the drain pan under the coil.
4. If drain pan appears soiled, pour some hot water mixed with liquid bleach (diluted solution) along the length of the pan to flush the dirt down the drain tube.
5. Continue this treatment until the drain appears clean and free of dirt.
6. Reinstall filter and grille or duct collar.
7. Plug in the unit and restart.

Cleaning the Humidifier (optional)

If the unit was furnished with a humidifier it requires periodic maintenance. Follow the instructions in the humidifier guide.

Heating Coil Option

The heating coil is located between the evaporator coil and blower inside the transition duct. It contains the heating element and high temperature limit switches. The heating coil is wired to work in conjunction with the thermostat. Since the thermostat prevents the heating and cooling circuits from being energized at the same time, no additional power wiring is needed. We do recommend using the AUTO mode on the thermostat so it can switch from heating to cooling automatically. If using either the heat or cool only mode, the thermostat will **not** switch automatically.

No additional maintenance is required for the heating coil. To test the heating coil operation, set the thermostat on HEAT and set the temperature above the cellar temperature. The supply air temperature should rise above the return air temperature by an amount shown in the specifications.

Low Ambient Option

The purpose of the low ambient option is to protect the compressor and refrigerant system. It has two distinct components, a crankcase heater to keep the oil in the compressor warm and prevent slugging on system start-up and a head pressure control to cycle the condenser fan on and off automatically to maintain system head pressure.

To confirm that the system is working, feel the bottom of the heater when the compressor unit has cycled off. When the unit starts, the condenser fan does not start at the same time as the compressor. The condenser fan starts after the head pressure has built up. As the unit is running the condenser fan cycles off and on while it holds the head pressure within a fixed range. The amount of cycling (frequency and duration) depends on the air temperature. The colder the air, the more frequent the cycling and with a longer duration.

Maintenance Schedule

Monthly

(or quarterly depending on experience with individual cellar)

- ✓ Check filter and drain trap – clean if needed.
- ✓ Check for noise or vibration.
- ✓ Check for short-cycling of the unit – a turning on and off of the compressor unit more than eight times/hour.

Yearly

(in addition to monthly)

- ✓ Replace filters if worn or plugged beyond cleaning.
- ✓ Check evaporator and condenser coils for dirt – use a vacuum with a brush attachment to clean the coils.
- ✓ Clean condensate pan under the evaporator coil by flushing. Be careful to keep the drain pans clear of any and all debris.
- ✓ Inspect cabinet for corrosion or rusting – clean and paint.
- ✓ Inspect for dirt buildup on or inside the unit. Clean unit by vacuuming or wiping it down.
- ✓ Check for loose insulation, fasteners, gaskets or connections.
- ✓ Check the wiring connections and integrity of cords.
- ✓ Examine ducts for any cracks or breach.
- ✓ Check fan and solenoid on humidifier.
- ✓ Replace humidifier pad (if used).

Troubleshooting



BEFORE PROCEEDING, READ AND UNDERSTAND THE SAFETY INFORMATION CONTAINED IN THE SAFETY SECTION OF THE WINE GUARDIAN MANUAL.

IMPORTANT

This section is intended as a diagnostic aid only. For detailed repair or parts replacement procedures, contact a qualified service company. Check the following table for some solutions before calling a service technician.

Typical Start-up Problems	
Possible Cause Loose, improper or defective thermostat or humidistat cable	Solution Check power, and thermostat or humidistat cable
Incorrect thermostat or humidistat (optional) settings	Check the thermostat and optional humidistat set up for the application
Changed settings on the thermostat	A common problem is not waiting long enough for the internal timers to complete their timed delay
Unit Does Not Start-up	
Power Switch Light is Off	
Possible Cause Switch not on No power to outlet Unit not plugged in	Solution Turn on switch Check circuit breaker and wiring Plug in the unit
Power switch light is on and the thermostat light is off	
Possible Cause No power to thermostat	Solution Check main control board for L.E.D. indication Check wiring for loose, broken or frayed connections Check wiring for proper splicing Remote interface controller may be faulty
Power switch light is on and the thermostat light is on	
Possible Cause Thermostat is not set up properly	Solution Check thermostat set up in the guide. Press fan ON switch to check evaporator fan only

***Unit is operating and blows evaporator air,
but the supply air is not colder than the return air from the cellar***

Possible Cause	Solution
Thermostat not set up properly Compressor not operating Condenser airflow is blocked Clean filter and coil (if needed) High pressure (HP) switch is open	Check thermostat setup on page 37 High pressure switch open (button up) Alarm will appear on thermostat Remove blockage Reset HP switch See reset instructions on page 55

Problems Controlling Cellar Temperature

NOTE: Problems are occurring even though the unit seems to be fully operational evaporator fan blows air into the cellar and compressor and condenser fan runs.

<i>Cellar Temperature too cold (below 51°) when unit is running</i>	
Possible Cause	Solution
Thermostat set too low on cooling Heating coil (optional) not operating Thermostat set too low on heating Thermostat not controlling temperature	Reset thermostat to higher cooling temperature Check for temperature rise across coil Reset thermostat to higher heating temperature Thermostat mounted in improper location
<i>Cellar Temperature is too cold (below 51°) when unit is not running</i>	
Possible Cause	Solution
Too much heat loss to adjacent spaces Cellar loads are too high	Increase insulation around the ductwork Check and clean filter and coil Coil frozen – shut off unit for two hours Install additional insulation Replace with larger sized unit

Problems Controlling Cellar Humidity

<i>Humidity too low or supply air is too cold, without optional humidifier</i>	
Possible Cause	Solution
Not enough evaporator airflow	Remove blockage in supply or return ductwork Check and clean filter and coil Coil frozen – shut off unit for two hours
Defective thermal expansion valve	If under warranty call for service If not under warranty call a refrigeration technician
Temperature set too cold	Raise temperature setpoint at thermostat
<i>Humidity too low, without optional humidifier</i>	
Possible Cause	Solution
No moisture being added to cellar	Add Wine Guardian humidifier or a room humidifier
<i>Humidity too low with optional humidifier</i>	
Possible Cause	Solution
Humidifier not operating	Check wiring for loose, broken or frayed connections Check humidistat set up Check for water flow and solenoid valve operation
Humidifier operating	Check for water being hot Check drip pad – replace if scaled No vapor barrier around cellar
<i>Humidity too high when unit is running but not cooling</i>	
Possible Cause	Solution
Compressor not operating	Check and reset high limit switch Clear blockage of condenser airflow
Ambient temperature is too high	Reduce temperature or draw condenser air from another space

<i>Humidity too high when unit is not running</i>	
Possible Cause	Solution
Unit needs to run to dehumidify	Run unit. Seal openings around doors (gasket and sweep)
<i>Humidity too high when unit is running and cooling</i>	
Possible Cause	Solution
Too much moisture in cellar	Poor vapor barrier installation Humidifier malfunction refer to the humidifier instructions. Add dehumidifier to surrounding space

Other Miscellaneous Problems

<i>Unit operates but the power switch light is not ON</i>	
Possible Cause	Solution
Bulb is burned out	Replace bulb
<i>Unit is leaking water</i>	
Possible Cause	Solution
Piping from unit to drain is trapped	Re-pipe to remove external traps
Trap plugged	Clean trap
Condensate pan plugged	Remove blockage and clean
Unit not level	Level with shims
<i>Unit is running properly, but the sound of the unit is objectionable</i>	
Possible Cause	Solution
Noise is from airflow	Redirect airflow Add baffles Add insulated ductwork
Noise if from unit	Add sound baffle between unit and occupied

High Pressure Switch has Shut Down the Unit

Every Wine Guardian unit has a manual reset high pressure switch in the refrigeration system. This switch shuts the compressor and condenser down if the head pressure in the system is too high. It is intended to protect the compressor. Restricted airflow through the condenser is the most common reason for the pressure to become too high. This can be caused by dust covering the filter or an obstruction blocking the airflow in the duct or grille.

Possible Cause	Solution
Head pressure in unit is too high because an obstruction is restricting air flow	Remove the obstruction in the duct or grille or clean the filter. Then restart the unit after resetting the using the high pressure switch.

Instructions to Reset High Pressure Switch

1. Remove the access panel, grille or duct collar at the condenser opening labeled “ Manual Reset High Pressure Switch → Remove panel to access ”
2. Locate the high pressure switch near the compressor (a cylindrical device piped into the refrigeration system with two wires a red button on the top).
3. Push in the button until it locks into position.
4. Push the rocker switch to restart the unit.

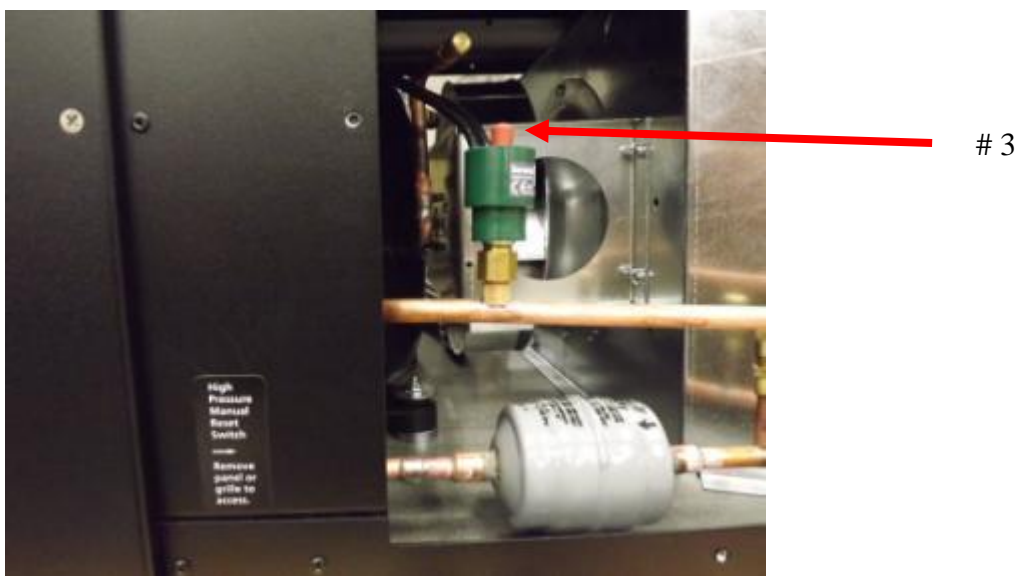

Advanced Troubleshooting

IMPORTANT

*This section is intended for qualified refrigeration service technicians only.
The technician should repeat all of the previous troubleshooting steps before taking action on these more technical solutions.*

Evaporator coil is freezing	
Possible Cause	Solution
Charge too low	Check sight glass Check for leaks Add refrigerant
TXV malfunctioning	Repair or replace
High pressure switch keeps tripping <i>Even After Checking for Obstructions and Dirty Filters/Coils</i>	
Possible Cause	Solution
Condenser fan not operating	Repair or replace
Defective switch	Replace
Unit cycles on and off more than 8 times/hr	
Possible Cause	Solution
Thermostat malfunctioning	Check the thermostat guide for thermostat information
Low suction pressure	Check low pressure switch Check pressure and adjust superheat
High pitched or loud rubbing noise, clanking or vibration	
Possible Cause	Solution
Fans loose or malfunctioning	Repair or replace
Excessive compressor vibration	Replace
TXV malfunctioning	Repair or replace
Replacing the blowers	
<i>NOTE: When replacing the fan or motor, replace the fan and motor as a unit. Do not remove the motor from the impeller wheel.</i>	

Warranty

GENERAL

Wine Guardian warrants, to the original buyer, its goods and all parts thereof to be free from defects in material and workmanship for a period of two (2) years from the date of invoicing assuming **NORMAL USE AND SERVICE**.

LIABILITY

Wine Guardian liability shall be limited to the repair or replacement (at its option) of any part, which, at our sole discretion, is determined to be defective. The purchaser shall pay all transportation costs. Additionally, if a malfunction occurs within the first year from the date of invoice, **Wine Guardian** will reimburse the reasonable cost of labor required for the repair or replacement provided authorization is obtained from one of our authorized representatives prior to incurring any labor charges.

LIMITATIONS OF LIABILITY

THESE WARRANTIES ARE MADE IN LIEU OFF ALL OTHER WARRANTIES EXPRESSED OR IMPLIED, INCLUDING ANY IMPLIED WARRANTY OF MERCHANTABILITY OR FITNESS FOR A PARTICULAR PURPOSE AND IN LIEU OF ANY OTHER OBLIGATION OR LIABILITY, INCLUDING LIABILITY FOR ANY INCIDENTAL OR CONSEQUENTIAL DAMAGES. **Wine Guardian** will not be responsible for any costs or liabilities whatsoever resulting from improper installation or service of its equipment. In the event that **Wine Guardian** or its distributors are found liable for damage based on any defect or nonconformity in the products, their total liability for each defective product shall not exceed the purchase price of such defective products. No person or representative is authorized to change these warranties or assume any other obligations or liabilities for **Wine Guardian** in connection with the sale of its systems.

INDEMNIFICATION

Purchaser agrees to indemnify, hold harmless and defend seller and its officers, directors, agents and employees from and against any and all claims, liabilities, costs and expenses arising out of or related to Purchaser's use of the goods, or in any way involving injury to person or property or accident occasioned by the goods sold by **Wine Guardian** to Purchaser.

FOREIGN GOVERNMENT AND INDIAN NATIONS

If Purchaser is a foreign government or an Indian nation, Purchaser hereby expressly waives its defense of sovereign immunity in the event of a dispute between Purchaser and **Wine Guardian** regarding this invoice and Purchaser expressly acquiesces to the jurisdiction of the federal and state courts of the United States.

SEVERABILITY

If one or more of the provisions contained in this contract shall for any reason be held to be invalid, illegal or unenforceable in any respect, such invalidity, illegality or unenforceability shall not affect any provision of this contract, but this contract shall be construed as if such invalid, illegal or unenforceable provision had never been contained.

ADDITIONAL REQUIREMENTS

If a defect covered by the Warranty occurs, contact Wine Guardian for authorization to proceed with corrective action. Do not return any parts or incur any charges for which you expect to be reimbursed under this Warranty without receiving this authorization. If parts are replaced under this Warranty, the defective parts must be returned prepaid within 30 days. This warranty shall be null and void in its entirety if the Serial Number on the air conditioner or compressor is altered, removed or defaced.

Contact and Warranty Information

Contact Information

Wine Guardian

7000 Performance Drive
North Syracuse, NY 13212
Toll free: (800) 825-3268

Service Department: press 3
Direct: (315) 452-7400
Service Department: ext. 7434

Normal business hours are 8 a.m. to 5 p.m. Eastern, Monday-Friday.
After hours, contact: (315) 391-8747

Web site: www.airinnovations.com
Email: info@airinnovations.com

Warranty and Warranty Procedure

The Wine Guardian unit serial number is noted on all packing lists and bills of lading and, along with the shipping date, is kept on file at Wine Guardian for warranty purposes. **All correspondence regarding warranty must include the model number and serial number of the unit involved.** Note that the warranty is null and void if the serial number on the unit or compressor is altered, removed or defaced. All inquiries or correspondence regarding warranty should be handled in accordance with the “Warranty” and directed to:

Wine Guardian

7000 Performance Drive
North Syracuse, New York 13212
Attn: Service Department
Toll Free: (800) 825-3268
Fax (315) 452-7420

This procedure includes but is not limited to:

- Obtaining authorization from Wine Guardian prior to incurring any charges for repair or replacement under warranty.
- Or returning prepaid within 30 days any and all defective parts.