



ADRD18



31.5" x 17.75" x 23.25" (H x W x D)

18" wide ADA compliant 2-drawer all-refrigerator in stainless steel with panel-ready drawer fronts for commercial or residential use

Highlights:

Flexible design allows for built-in or freestanding use in 18" wide spaces

Panel-ready drawers allow you to customize the look to match existing cabinetry

32" height for use under lower ADA compliant counters

Product Features:

18" wide drawer refrigerator	Two-drawer design in a unique 18" width ideal for undercounter spaces
ADA compliant	32" height allows for installation under lower ADA compliant counters
Commercially approved	ETL-S listed to NSF-7 standards for commercial use
Panel-ready drawer fronts	Drawers can be customized with overlay panels sized (at 14" H x 17.7" W at 3/4" thick) to match or accent existing cabinetry
Built-in capable	Front-breathing design allows the unit to be built-in under counters
Stainless steel construction	Complete 304 grade stainless steel inside and out to ensure lasting durability with a luxurious look
Indoor/Outdoor compatible	Durable, weatherproof construction designed to hold up to the elements
Professional handles	Stainless steel handles add style to any setting
Frost-free	No-frost operation for minimal user maintenance



ADRD18 Specifications:

Overview	
Height of Cabinet	31.5" (80 cm)
Width	17.75" (45 cm)
Depth	23.25" (59 cm)
Depth with Handle	25.0" (64 cm)
Depth with door at 90°	37.0" (94 cm)
Capacity	3.4 cu.ft. (96 L)
Defrost Type	Frost-Free
Door	Stainless Steel/Panel-Ready
Cabinet	Stainless Steel
US Electrical Safety	ETL
Canadian Electrical Safety	ETL-C
Sanitation	ETL-S
Energy Usage/Year	259.0kWh/year
Amps	1.25
Voltage/Frequency	115 V AC/60 Hz
Weight	100.0 lbs. (45 kg)
Shipping Weight	117.5 lbs. (53 kg)
Parts & Labor Warranty	1 Year
Compressor Warranty	5 Years
UPC	761101083544
Refrigerator Features	
Sabbath Mode	Yes
Door Swing	Drawer
Thermostat Type	Digital
Fan Type	Interior and Exterior
Refrigerant Type	R600a
Refrigerant Amount	1.23oz.
High Side PSI	150.0
Low Side PSI	50.0
Level Legs Qty	4
Interior Light	Yes
Interior Drawers	Yes
Interior Drawers Qty	2
Temperature Range	34 to 65°F
Sound Level	34.3 dB

Drawer Dimensions	
Interior Height 1	8.75" (22 cm)
Interior Width 1	12.75" (32 cm)
Interior Depth 1	17.5" (44 cm)
Interior Height 2	10.5" (27 cm)
Interior Width 2	12.75" (32 cm)
Interior Depth 2	17.5" (44 cm)
Dimensions	
Compressor Step Height	5.75" (15 cm)
Compressor Step Width	12.75" (32 cm)
Compressor Step Depth	4.75" (12 cm)

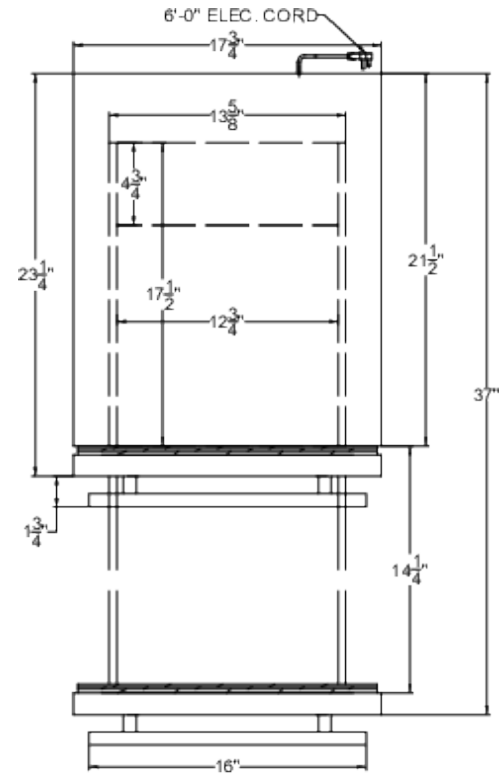

TOP VIEW

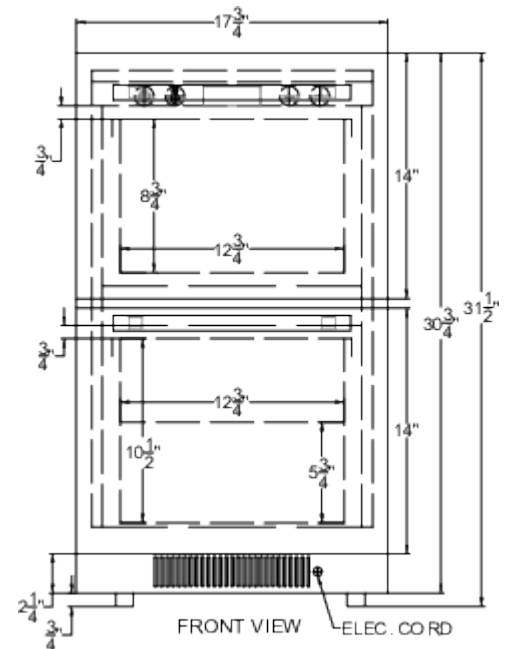

FRONT VIEW