

DIRECT DRAW KEG REFRIGERATORS



DIRECT DRAW KEG REFRIGERATORS

EBD – Series

• EBD1 • EBD2 • EBD3 • EBD4



EBD1



EBD2



EBD3



EBD4

Cabinet Construction

Heavy duty stainless steel countertop and rail, textured and laminated black vinyl exterior. Galvanized steel interior wall, and high quality stainless steel floor. 1 3/4" thick high density foamed-in-place polyurethane insulation. Pre-installed four 4" diameter casters for single door unit. Built-in caster thread receptacles for all units.

Refrigeration System

- Back mounted condensing unit for single door, and side mounted condensing unit for two and three door models
- Oversized condenser and evaporator coils quickly achieve and maintain desired temperature
- Forced-air cooling with oversized evaporator fan motors providing balanced airflow throughout cabinet to ensure faster temperature drop
- Removable side panel and slide-out condensing unit for convenient repair and maintenance
- Environmentally friendly CFC free R-134A refrigerant
- Air defrost controlled by electrical timer
- Copper tube and aluminum fin evaporator with anti-corrosive coating
- Energy efficient condensate drain pan assembly heated by high side copper tube
- Pre-wired and ready to plug, 115V/60Hz/1Ph, NEMA 5-15P

Doors

- Textured and laminated black exterior with galvanized steel interior
- 1 3/4" thick high density foamed-in-place polyurethane insulation
- One piece snap-in magnetic door gaskets for easy replacement
- Heavy duty recessed door handles for a flat surface
- Door locks

Draft Arms

- NSF approved 3" diameter insulated stainless steel draft arm with air distributor
- One draft arm for model EBD1, and two draft arms for two and three door models

Lighting

- Shielded incandescent interior lighting with on/off switch (except model EBD1)

Temperature Control

- Factory preset temperature, 35°F
- Temperature setting range from 32°F to 42°F
- Easy to set analog thermostat

Options

- 2 1/2" and 4" diameter casters (3 1/2" and 5" overall height)
- Dual faucet towers

• Project / Customer _____

• Item No. _____

• Model No. _____

Warranty

 **5 Year — Compressor Warranty**
3 Year — Parts & Labor Warranty
Applicable to units purchased after July 1, 2014.

Contact

 201 W. Artesia Blvd, Compton, CA 90220
T. (310) 323-6586, (800) 444-6285
F. (310) 323-7524

DIRECT DRAW KEG REFRIGERATORS



EBD – Series

• EBD1 • EBD2 • EBD3 • EBD4

Dimensions

SIDE VIEW (All models except EBD1)

★ 3/4" O.D.

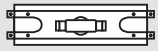

T-Shaped PVC
Drain Fittings w/
Moveable Plug

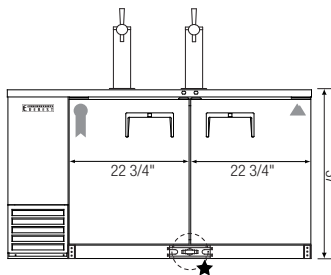
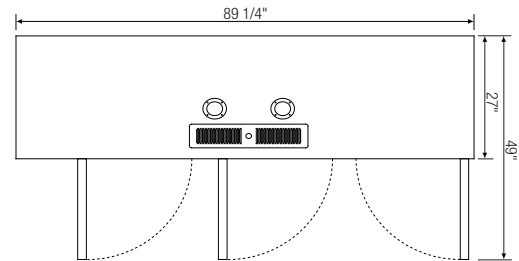
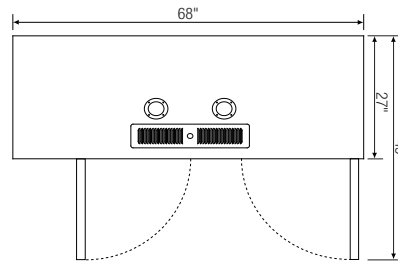
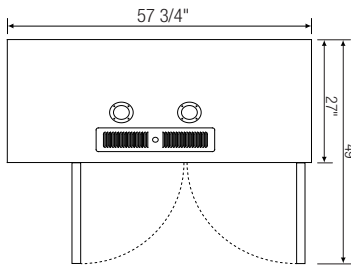
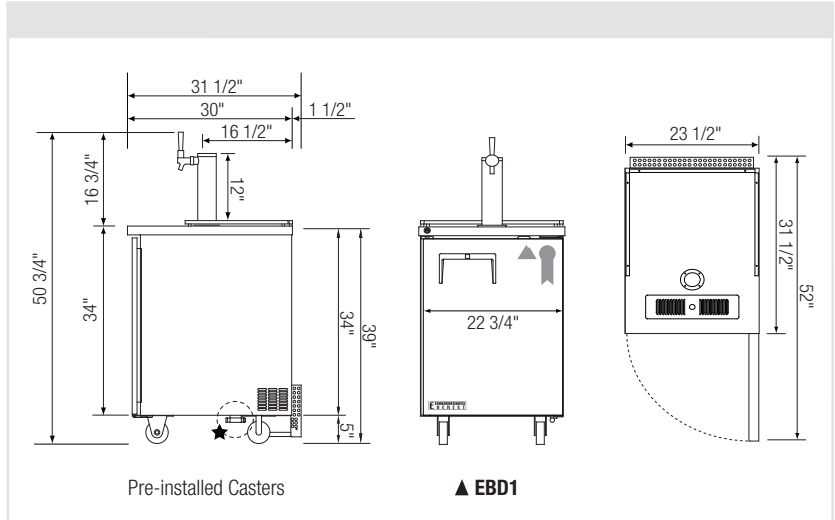
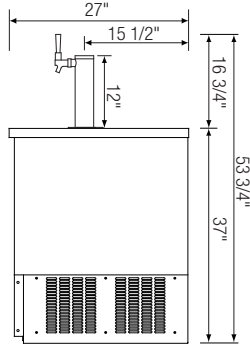

▲ EBD2

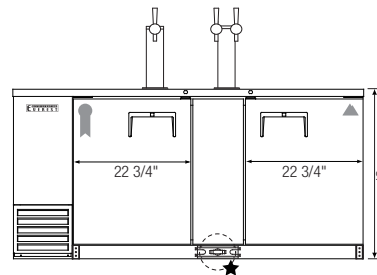

▲ EBD3

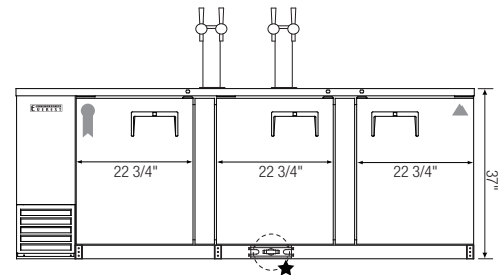

▲ EBD4

Model	Ref/ Fzr/ Dual	# of Doors	# of 1/2 Barrels	Capacity (Cu.Ft.)	HP	Refrigerant	Power (V-Hz-Ph)	Amps	Crated Weight (LBS)	Exterior Dimensions (Inches)			* Height does not include towers a Depth includes 1 1/2" for back grill b Height includes 5" for casters Ref = Refrigerator Fzr = Freezer Dual = Ref & Fzr Combo
										L	D	H*	
EBD1	Ref	1	1	8.19	1/6	R-134A	115-60-1	3.90	154	23 1/2	31 1/2 ^a	39 ^b	
EBD2	Ref	2	2	20.09	1/4	R-134A	115-60-1	4.20	271	57 3/4	27	37	
EBD3	Ref	2	3	24.01	1/4	R-134A	115-60-1	4.20	304	68	27	37	
EBD4	Ref	3	4	32.37	1/3	R-134A	115-60-1	4.50	355	89 1/4	27	37	

Disclaimer: Product dimensions are for general purposes and not absolute value. Slight variations may exist. If dimensions are critical, please contact Everest.