

KEGENERATOR CONVERSION KIT GUIDE



Kegco

1-888-980-4810



SAFETY PRECAUTIONS

- » Always wear safety glasses and gloves when handling chemicals.
- » Always use a gas pressure regulator and keg coupler. Never exceed 60 psi.
- » Never remove the valve in the keg.
- » Always secure CO₂ tank in an upright position and keep away from heat. Store CO₂ tank under 70° F.
- » Never drop or throw the CO₂ tank.
- » Ventilate the area well in the case of a leakage. *If it becomes difficult to breathe and your head starts to ache, high levels of CO₂ (carbon dioxide) may be present in the area. LEAVE THE ROOM IMMEDIATE
- » **California Proposition 65 Warning:** This product contains a chemical or chemicals known to the State of California to cause cancer and birth defects or other reproductive harm.



CLEANING DIRECTIONS & IMPORTANCE

As beer is run from the keg through your system, the components are left coated with a beer film which provides a place for bacteria and other unwanted organisms to grow. Having beer flow through a dirty system will taint the quality of the beer.

In most states, bars are required to clean their systems twice a month, and in some states it is required more frequently. To clean, first shut off the CO₂ at the regulator. Remove the keg coupler from the keg, disassemble the air hose and beer line from the coupler, unscrew the faucet from the system and clean all these parts by soaking and/or scrubbing with soap and water.

Cleaning detergents are also an important aspect, ensuring the system is thoroughly clean. There are many cleaning products, pressurized bottles and brushes made just for cleaning beer systems, and all of them are available at **Beverage Factory.com**.



The **Kegco** kegerator conversion kit supplies everything needed to turn that old refrigerator into a completely functional kegerator, where the ability to pour fresh cold draft beer will be a daily occurrence. Impress friends and family with this home addition while entertaining guests.

GETTING STARTED

Before you begin, make sure that all the shelves are removed from the refrigerator, the bottom drawers are reinforced and you have a minimum available inside space of 18" x 28" inches.

In a **Kegco** conversion kit comes everything you need to make this conversion happen, including a CO₂ gauge, coupler, hoses and clamps, shank, faucet and knob.

The largest common keg is 17" (inches) in diameter, while the CO₂ tank is 8" — both should fit inside the refrigerator. In some cases, an external CO₂ mount is needed.

REFRIGERATOR TOP VIEW

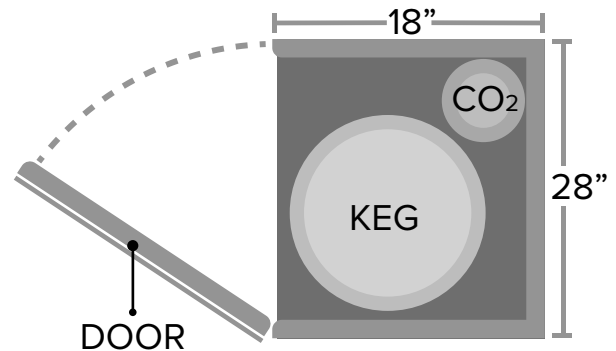

COMMON KEGS & CO₂ TANKS

Below are the specifications for the common kegs and CO₂ tanks. Make sure that both can fit standing upright in your refrigerator before you begin. In some cases, if you cannot fit both in, an outside mount is available for the CO₂ tank. Please allow 8" of height clearance for the keg coupler.

Allow about 8" of height clearance for coupler.									
	1/2 Barrel	1/4 Barrel	1/4 Slim	1/6 Keg	20 lb.	15 lb.	10 lb.	5 lb.	2.5 lb.
Height	23.3"	14.8"	23.3"	23.3"	28"	24"	21"	19"	13"
Diameter	17" *	17" *	11"	9.25"	8"	7.5"	7"	6"	5"
Capacity	15.5 Gal.	7.75	7.75	5.23	20 lbs.	15 lbs.	10 lbs.	5 lbs.	2.5 lbs.

*Coors kegs are barrel shaped with a max. diameter of 18"

REQUIRED TOOLS



THE BASIC IDEA

The Keg is a pressurized container ready to supply you with beer. The CO₂ tank regulates and maintains the pressure in your keg so you can dispense beer at any given time without using one of those pumps that you might remember from college.

- Maintaining the Equipment -

Through the ongoing use of the system, build-up accumulates in the hoses that needs to be cleaned out on a regular basis. As beer is run from the keg through your system, the components are left coated with a beer film which provides a place for bacteria and other unwanted organisms to grow. There are kits sold for cleaning that are simple and easy to use.

- Shelf Life -

Beer does not have a shelf life - be sure to store only the amount of beer that you can go through in a given period of time. Generally, the larger companies give their beer between 110 and 140 days on the market before it is pulled off the shelves. Most kegs are supplied with an expiration date.

PREPARING THE FRIDGE

Turning that old refrigerator into a great functioning kegerator is simple and only requires a few quick steps. After measuring your equipment and making sure that all the components will fit, clear out the refrigerator, removing all shelves.

If you have bottom drawers and choose to leave them in, be sure to support them with something such as a piece of plywood. A full keg, weighing approximately 160 lbs. Can break through the plastic.



COMPONENTS

The Kegco kegerator conversion kit comes with a faucet and knob, coupler, hoses, clamps, a shank and a CO₂ pressure gauge. Additional parts could include drip a tray, an upgraded faucet and more.

	<p>FAUCET AND KNOB - You can't pour beer without this gadget. Made with a high polish so it looks and works well and is easy to clean.</p>		<p>CO₂ GAUGE - This pressure gauge allows you to monitor the pressure inside your CO₂ tank and the pressure of the gas going into the keg.</p>
	<p>BEER HOSE - This hose is clear so you can monitor times between cleaning. Connects the keg to the faucet through the coupler and the shank.</p>		<p>AIR LINE - This hose connects the CO₂ Tank to the keg through the keg coupler and CO₂ regulator.</p>
	<p>KEG COUPLER - The coupler opens the keg to allow gas in, pressurizing the keg, and allowing the beer to flow out to give you the product you enjoy.</p>		<p>CO₂ TANK - The tank maintains a consistent pressure in the keg at all times and prevents your beer from going flat.</p>
	<p>SHANK - The shank goes through the refrigerator and connects the faucet and the keg with the beer hose.</p>		<p>DRIP TRAY - The drip tray provides a platform for pouring as well as catching overflow. Available with or without a drain.</p>

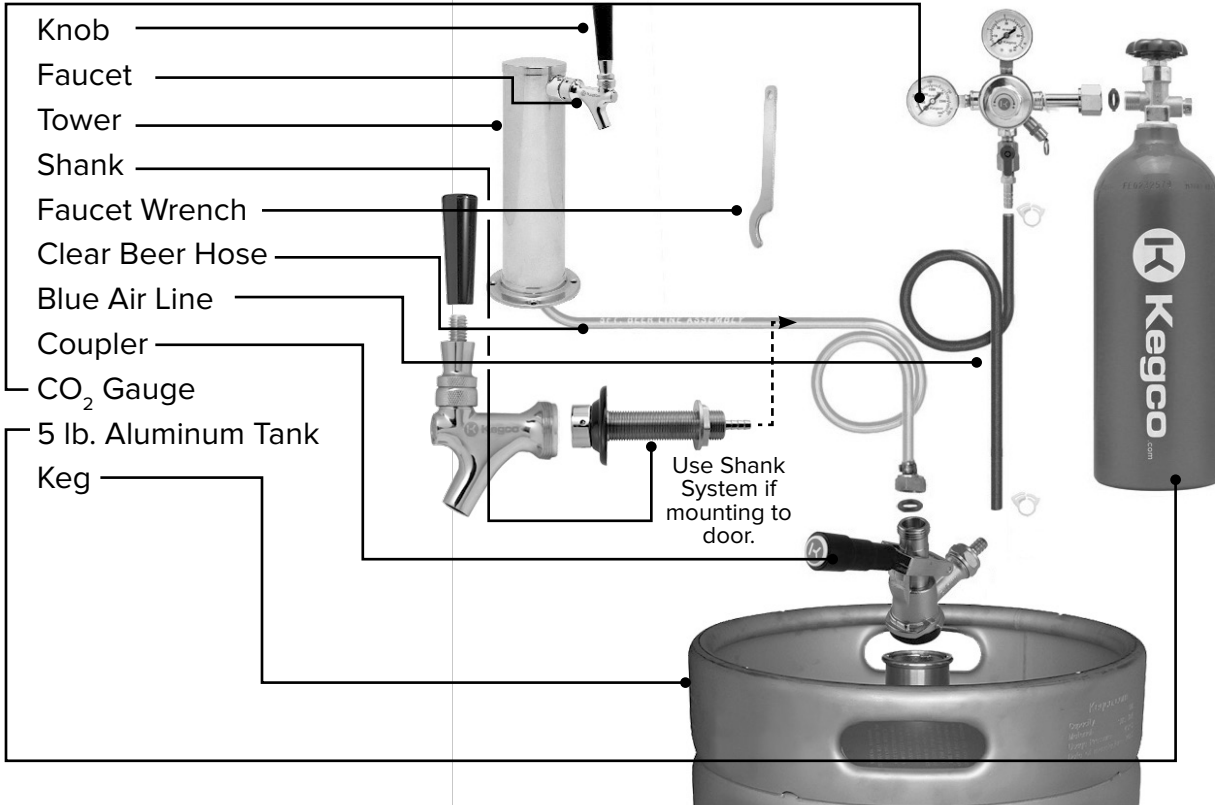

COMMERCIAL KEG CONFIGURATION



COMPLETED DIAGRAM

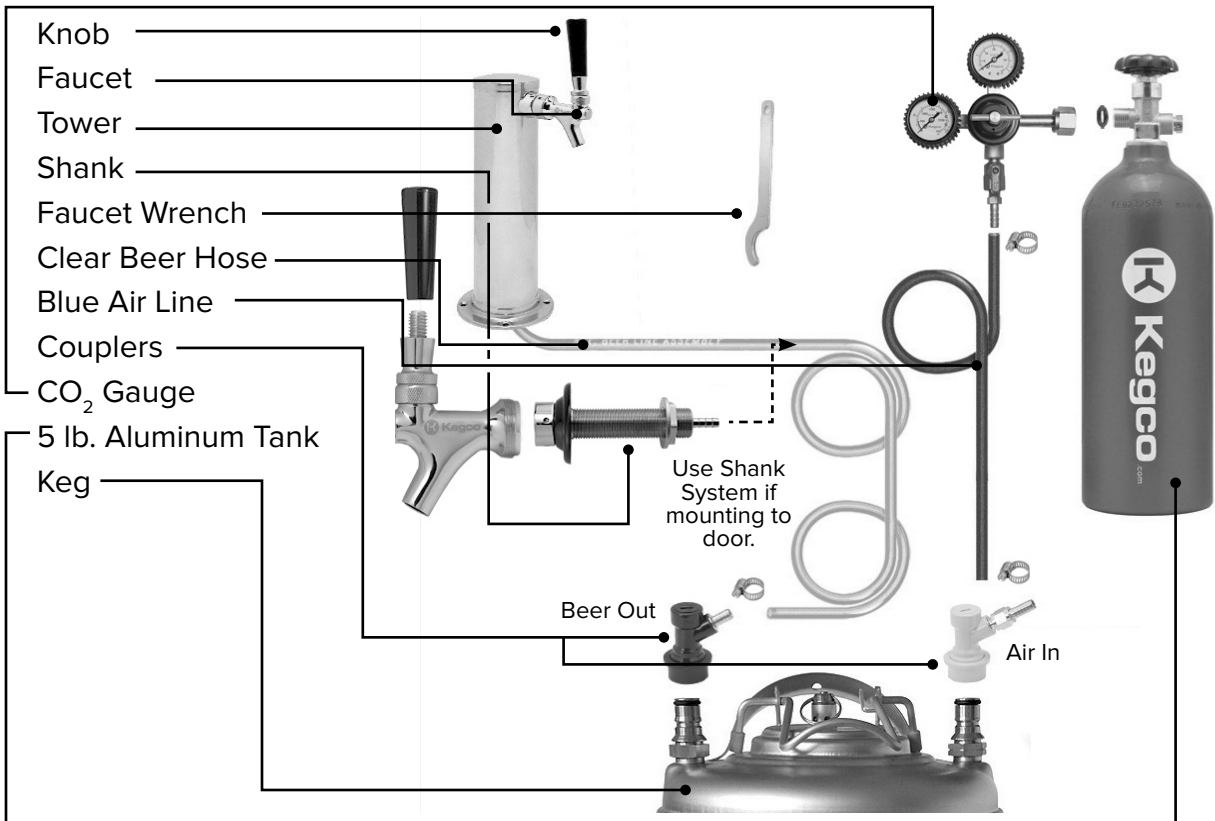

HOME BREW KEG CONFIGURATION



TOWER KIT INSTALLATION

Step 1 - Mark and Drill

Mark spot on top of your freezer cabinet and drill a 1-1/2" hole straight through.

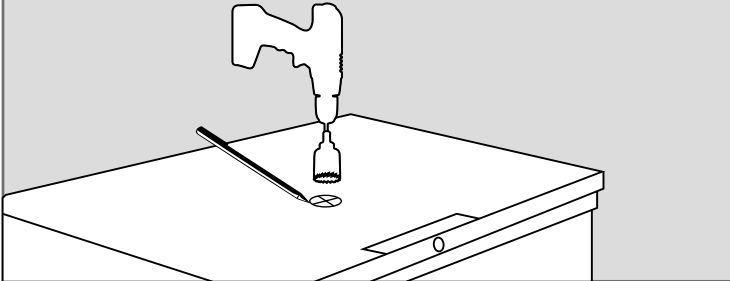

Step 2 - Screw Down Tower

Position tower and screw all 4 screws down to freezer cabinet.

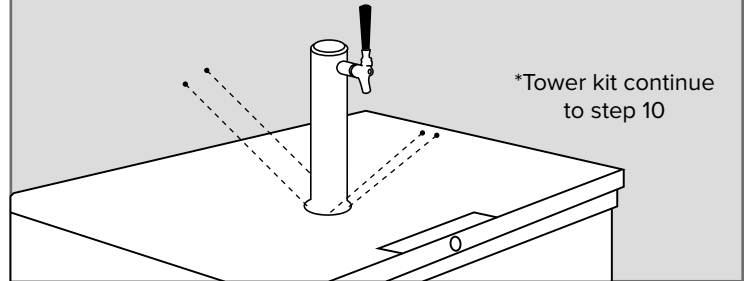

DOOR KIT INSTALLATION

Step 1 - Mark Inside of Door

Start on inside of door - Find good flat area for a hole and mark it.

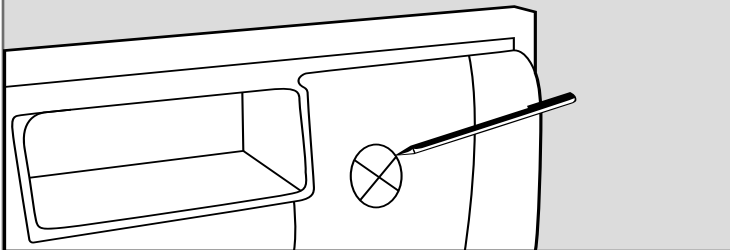

Step 2 - Measure and Mark

Measure in from the side and top.

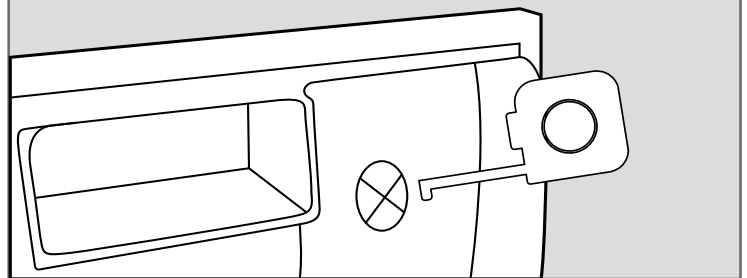

Step 3 - Transfer Measurements

Transfer measurements to the outside of door and mark.

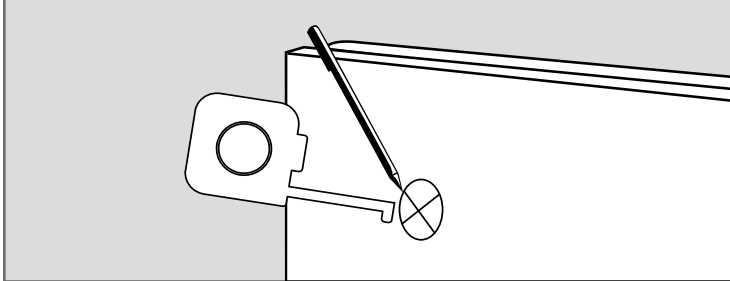

Step 4 - Drill From Outside

From outside, drill a 1/4" pilot hole all the way through the door.

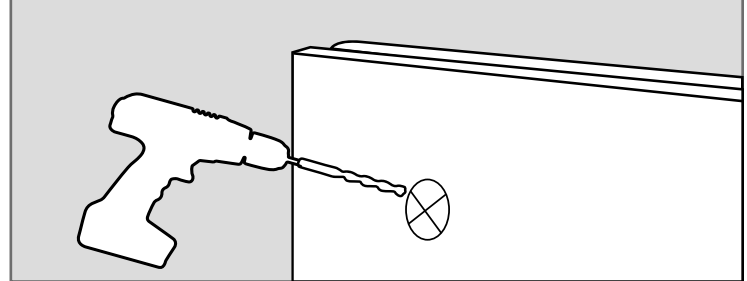

Step 5 - Drill from Inside

Drill a 7/8" hole over pilot JUST THROUGH inside door skin.

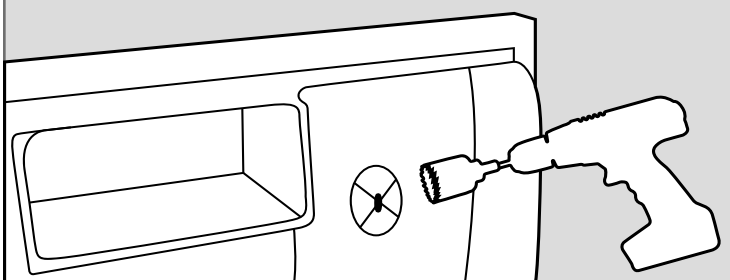

Step 6 - Drill from Outside

Drill a 1-3/8 hole through outside door skin.

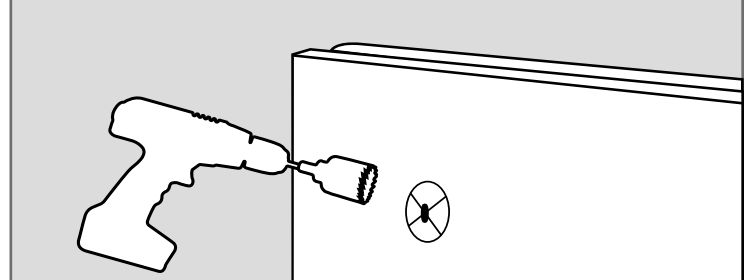

Step 7 - Measure Thickness

Measure the depth of the hole in the door and mark.

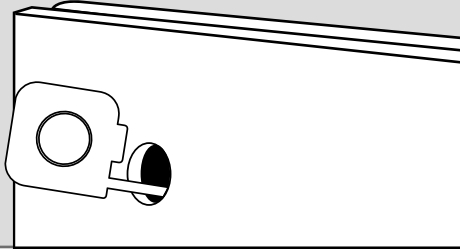

Step 8 - Cut PVC Spacer (Optional)

With hacksaw, cut a PVC spacer 1/8" shorter than the thickness of the hole in the door.

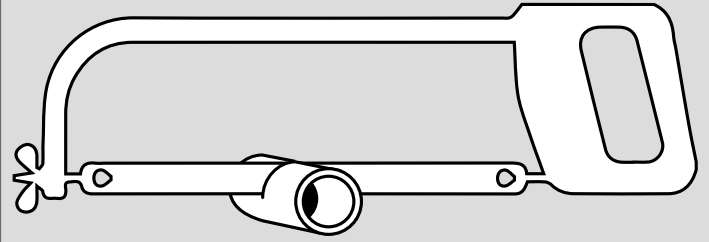

Step 9 - Insert PVC (Optional)

Insert the PVC spacer into the hole in the door.

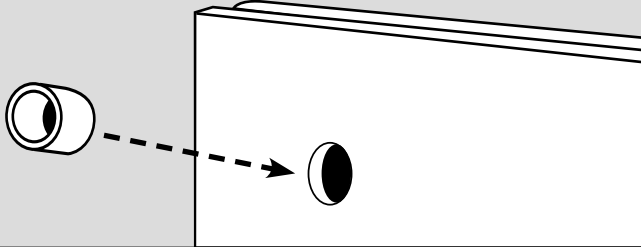

Step 10 - Connect Faucet Knob to Faucet

Connect knob into faucet and tighten.

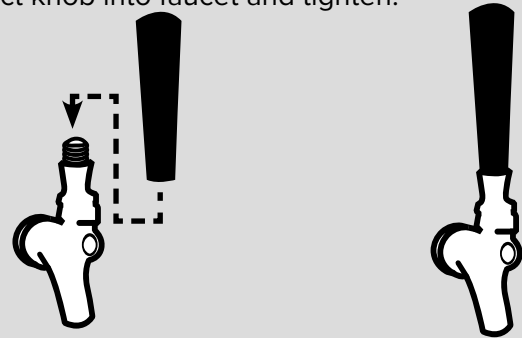

Step 11 - Connect Faucet to Shank

Connect faucet to shank or tower and tighten with shank wrench. Do not over tighten.

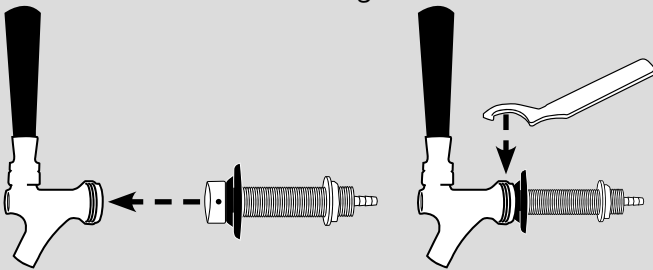

Step 12 - Insert shank

Insert shank with black washer on the outside through the PVC spacer.

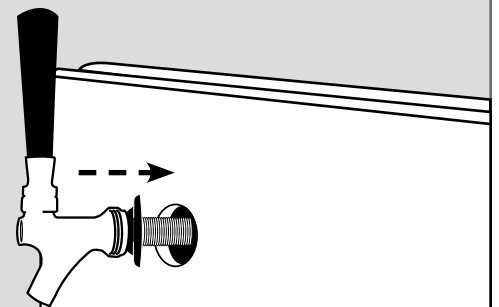

Step 13 - Install Shank Nut

Install shank nut over barbed end and tighten firmly.

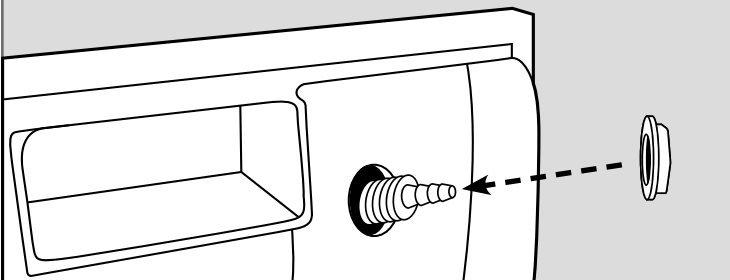

Step 14 - Add Hose Clamp

Slide a hose clamp over the thin end of the clear beer hose.

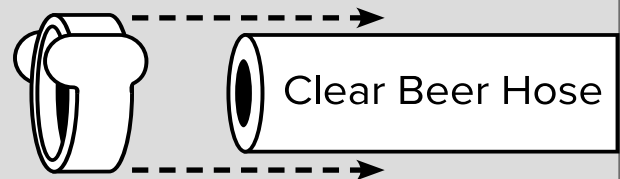

Optional - Put Tubing in Heated Water

This makes it very easy to attach to the hose nipples on the shank and the coupler.



Step 15 - Attach Beer Line to Shank

Push the thin end of the beer line into the barbed shank.

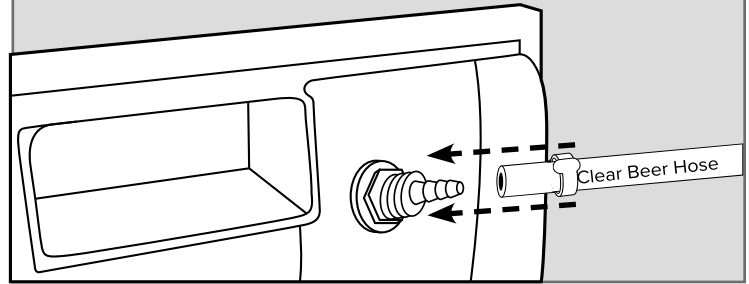

Step 16 - Fasten Hose with Clamp

Slide the clamp over the barbed end of the hose and shank. Squeeze firmly to tighten.

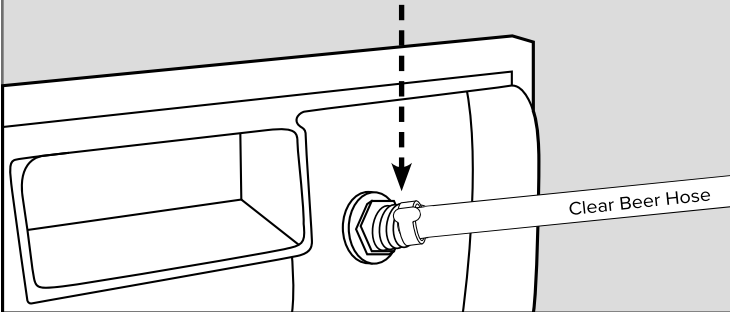

Homebrew Only - Remove Nut from Beerline

In order to install the beer line onto the Homebrew coupler, the Nut needs to be removed.

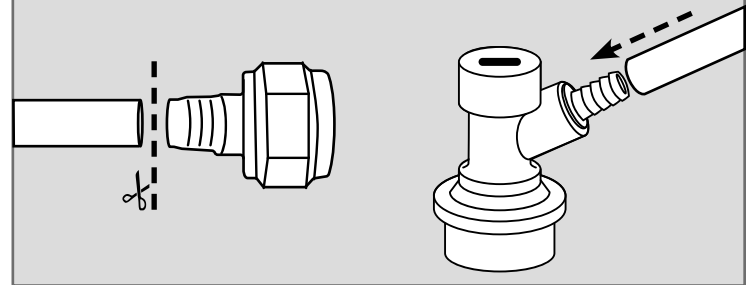

Step 17 - Insert Black Washer

Insert black washer into the nut end of the beer line.

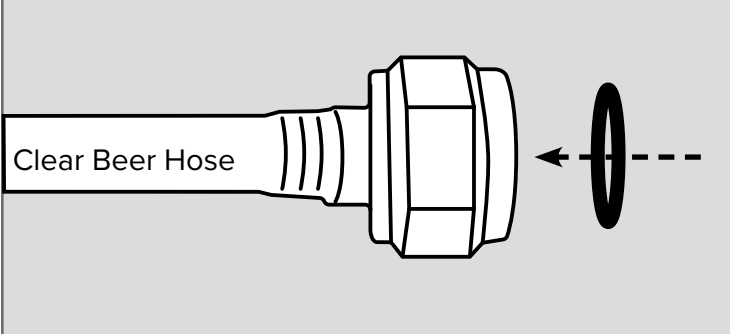

Step 18 - Attach Line to Coupler

Screw the nut end down onto the coupler and tighten with a wrench.

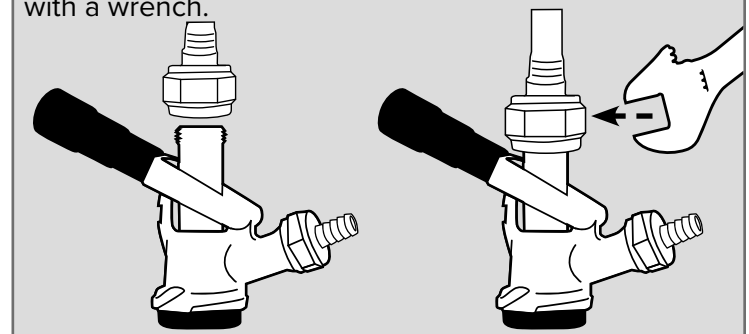

Step 19 - Add Hose Clamp

Slide a hose clamp over one end of the air hose.

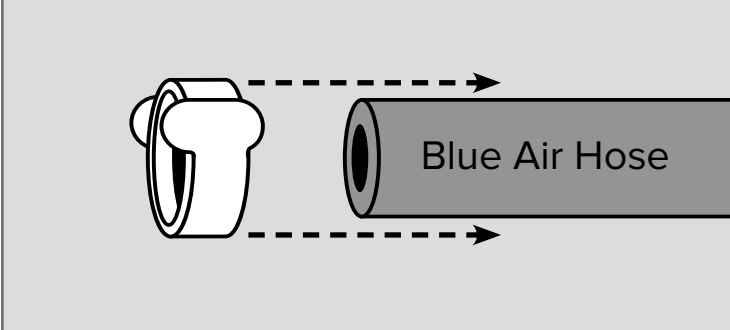

Step 20 - Attach Air Line to Coupler

Push that end of the air line over the barbed end of the coupler.

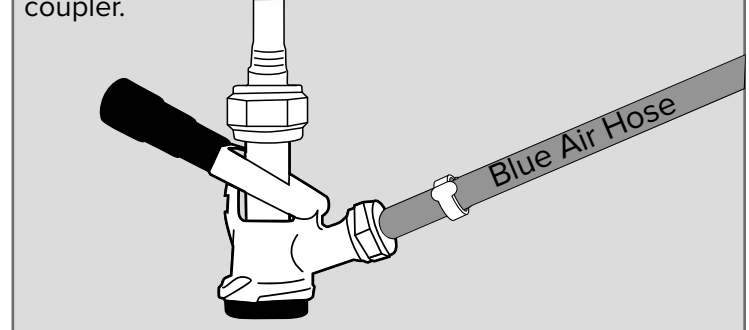

Step 21 - Fasten Hose with Clamp

Slide the clamp over the hose and coupler, then squeeze firmly to tighten.

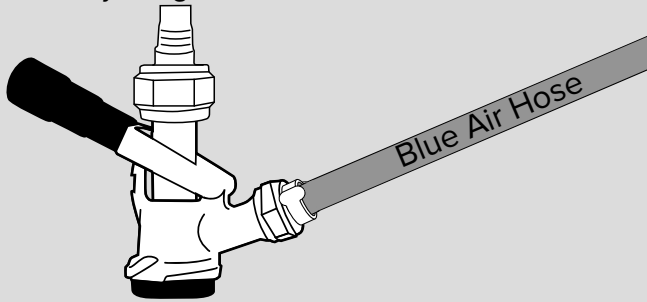

Step 22 - Add Hose Clamp

Slide a hose clamp over the other end of the air hose.

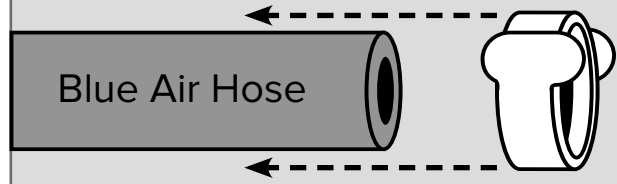

Step 23 - Attach Air Line to Regulator

Push that end of the air hose over the barbed end of the CO₂ regulator.

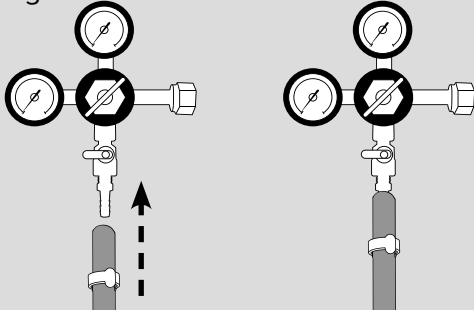

Step 24 - Fasten Hose with Clamp

Slide the clamp over the regulator and hose. Squeeze firmly to tighten.

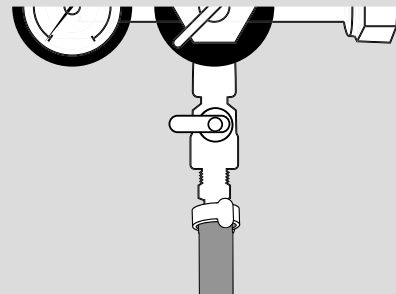

Step 25 - Attach Regulator to Tank

Attach regulator to CO₂ tank and tighten firmly with wrench. DO NOT OVER TIGHTEN

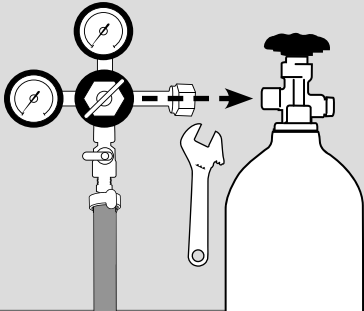

Step 26 - Insert Coupler into Keg

With handle in the up position, insert coupler into keg.

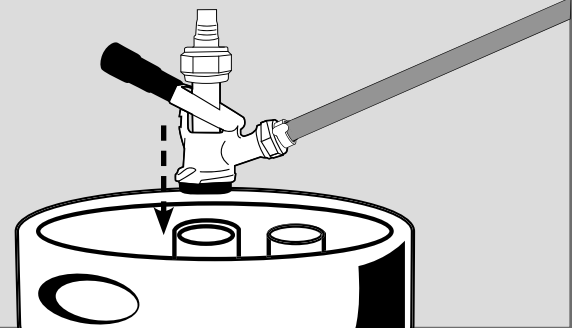

Step 27 - Rotate Coupler

Rotate coupler counter clockwise until it stops.

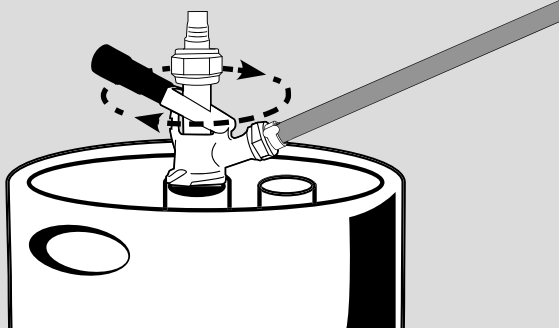

Step 28 - Push Down Handle

Pull out on handle and push down until it clicks.

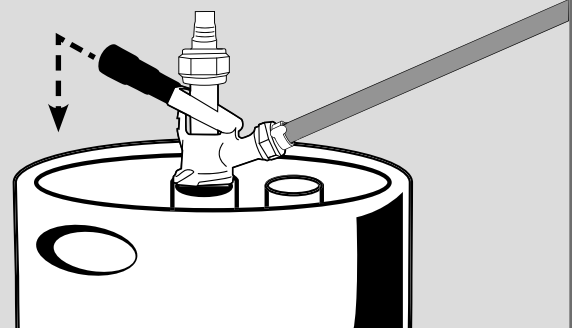

Step 29 - Open Regulator Valve

Turn the regulator valve to the on position.

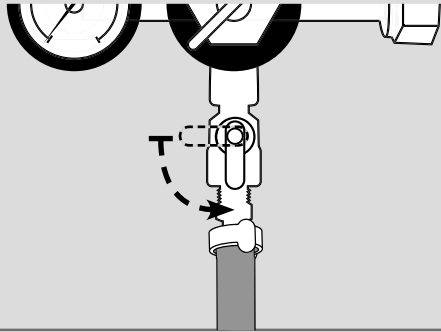

Step 30 - Open Valve on Tank

Turn the tank valve to the on position. (Counter clockwise)

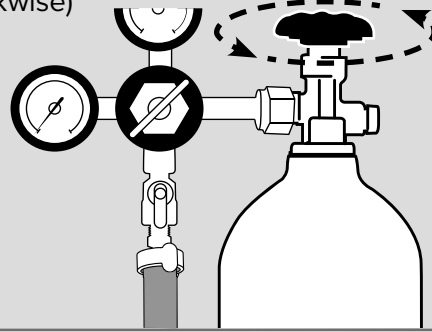

Step 31 - Adjust CO₂ Pressure

Adjust the regulator to read 10 to 12 PSI by turning the handle clockwise.

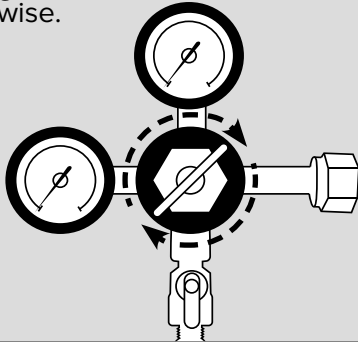

Step 32 - Left Gauge

Gauge on the left indicates total tank pressure. This will drop as the tank empties.

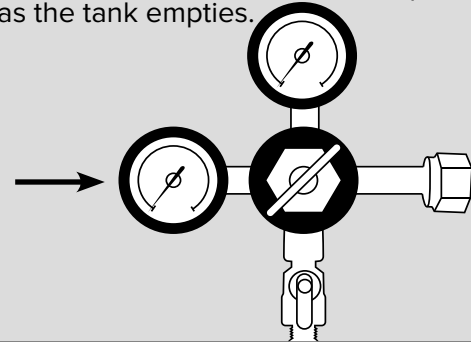

Step 33 - Install Thermometer (Optional)

Install the manual thermometer

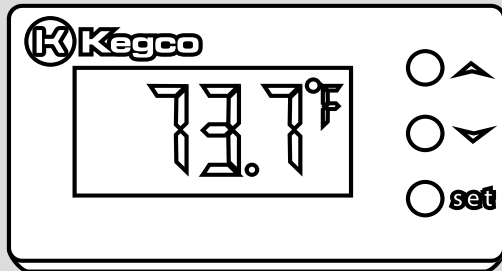

Step 34 - Completed . . . Enjoy!

Your System is complete. Pour a glass of beer and taste the reward of hard work!



CARBONATION TIP:

CO₂ solubility increases with increasing pressure and decreases with increasing temperature. What that means to you is that you may experience foamy or flat beer depending on your CO₂ pressure, beer temperature and atmospheric pressure. Most beers are considered normally carbonated with 2.45 to 2.85 volumes of dissolved CO₂. It's important to remember that carbonation is proportional to absolute pressure, not gauge pressure. Atmospheric pressure drops as elevation rises. Therefore, the gauge pressure needed to achieve proper carbonation at elevations above sea level must be increased. Add 1 psi for every 2,000 feet above sea level.

For example, a kegerator at sea level would use 11.3 psi gauge pressure to maintain 2.5 volumes of CO₂ in beer served at 38°F. That same kegerator would need 13.3 psi gauge pressure at 4,000 feet elevation to maintain 2.5 volumes of CO₂.

DRIP TRAY INSTALLATION

The drip tray is a must-have for any door or wall mounted kegerator faucet. With this addition to your kegerator, you get a platform to rest glasses on when pouring and something to catch any overflow. For added convenience, install a drip tray with a drain.

Step 1 - Measure from Shank

Mark a horizontal line on the front of the door about 12" inches below the shank hole.

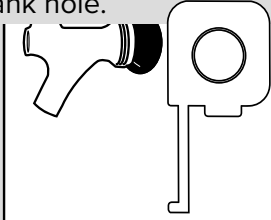

Step 2 - Screw on Drip Tray

Mark the holes for the drip tray and put screws into the door to hold the tray in place.

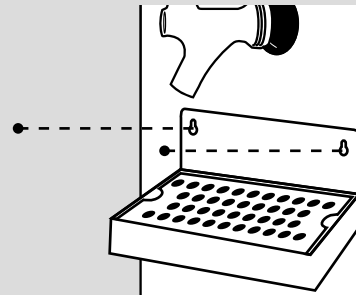

Step 3 - Drill Hole (Optional)

About 8" inches under the drip tray, drill a hole straight through the door.

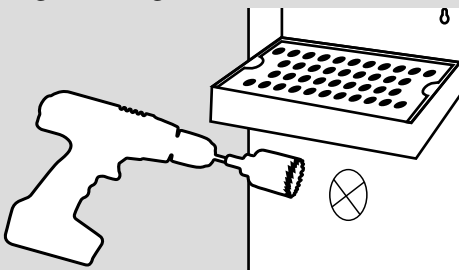

Step 4 - Completed ... Enjoy!

Attach a hose to the drip tray return and feed it through the door and into a container such as an old milk bottle.

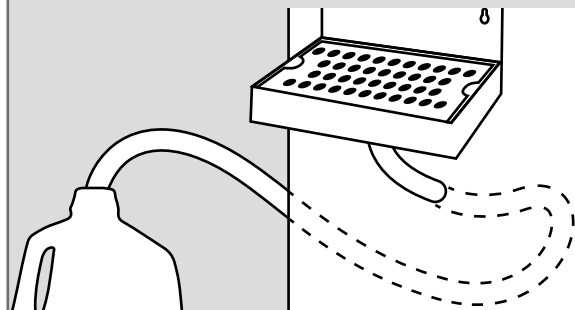

POURING TIPS AND TRICKS

To pour the perfect beer every time, keep your system clean and use a clean glass. When your faucet, beer hose, coupler or even your beer glass is dirty, the beer can come into contact with oils, dirt or residuals that will hinder head creation and spoil flavors.

To Pour a Perfect Beer

1. Start by holding your glass at a 45° angle, and let the beer fall about halfway down the glass.
2. When the glass is half filled, hold the glass straight up to create the perfect amount of head. Enjoy.

Another note - there are different glasses for different types of beers, all of which can be purchased right here from the professionals at Kegco.com.

TROUBLESHOOTING YOUR DISPENSE SYSTEM

If you are having issues with your dispense system, refer to the troubleshooting guide below. If these tips do not solve the problem, please give us a call at 1-888-980-4810 for assistance.

ISSUE	POSSIBLE CAUSES	SOLUTION
Foamy Beer (too much foam, not enough beer)	Temperature too warm	Most beers need to be between 32-38 degrees in order to remain in their liquid form.
	Poor pour	Hold the glass at 45 degrees, pour to the midpoint of the glass and tilt the glass upright as you reach the halfway point.
	Too much CO ₂	Reduce the CO ₂ output, pull the relief valve on the coupler to release excess pressure and adjust output up as you are pouring.
	Beer lines too long	Beer lines longer than 6 feet can cause issues.
	Obstructions in the line	Use a cleaning kit to ensure that the lines are free from protein and mineral build-up.
	Worn out beer faucet	Make sure the faucet opens fully and replace any parts as needed.
Cloudy Beer (Glass appears hazy instead of clear)	Temperature too cold	Most beers need to be between 32-38 degrees in order to remain in their liquid form.
	Dirty glass or faucet	Wash glasses and faucet and allow to air dry. Rinse glasses in cold water prior to pouring.
	Something warm touching keg	Remove any unrefrigerated items that may be contacting the keg.
	Old beer	Get a new keg.
Flat Beer (Head disappears quickly and lacks bubbles)	Dirty glass	Wash glasses and allow to air dry. Rinse glasses in cold water prior to pouring.
	Not enough CO ₂	Verify that you have CO ₂ in your tank and that the output pressure is set correctly. Make sure that your regulator is operating properly.
	Poor pour	Hold the glass at 45 degrees, pour to the midpoint of the glass and tilt the glass upright as you reach the halfway point.
False Head (Large soap-like bubbles)	Dry Glass	Rinse glasses in cold water prior to pouring.
	Small beer line into large shank	Ensure that the inner diameter of the shank is the same size or smaller than the inner diameter of your beer line.
	Beer lines warmer than keg	Make sure your entire beer line is refrigerated and at a cool enough temperature.
Bad tasting beer (Bitter taste with bad mouthfeel)	Dirty beer lines	Clean the lines after each keg or once a month, whichever comes first.
	Dirty air lines	Clean or replace your air line.
	Unsanitary bar conditions	Keep the dispense area clean. Use spout plugs to prevent dirt and insects from getting into your faucets.

KEG COUPLERS

Not all kegs use the same coupler. If you are planning on serving imported beers or your own home brew, we have a wide selection of couplers to tap all sorts of kegs from all over the world. Here is a sampling of the types of couplers available.



“A” System
Hacker Pschorr,
Hoegaarden,
Paulaner,
Spaten,
Warsteiner



“S” System
Amstel, Becks,
Heineken,
Pilsner Urquel,
Stella Artois



“G” System
Anchor Steam,
Boddington,
Cafrey’s,
Groelsh



“U” System
Guinness,
Harp,
Kilkenny



“M” System
Aventinus,
Schneider,
Einbecker



Ball Lock
Home Brew
Cornelius Pepsi
Kegs

DRIP TRAYS

We offer a variety of stainless steel drip trays for wall mount, surface mount and flush mount applications. They feature detachable grills and a dishwasher-safe design for easy clean up.



6” Wall Mount Tray No Drain
This drip tray is 6”x4” and is mounted to the door using two screw holes on the back splash.



12” Surface Mount - No Drain
This is a 100% stainless steel surface mount drip tray with attractive brushed finish.

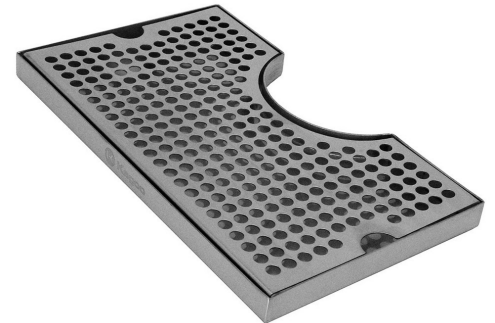

12” Tray - 3” Column Cut-Out
The cut-out is designed to wrap around a 3” wide draft beer tower column.

PREMIUM FAUCETS

We have premium beer faucet options available, from stainless steel faucets to self-closing faucets to stout faucets to Perlick Forward Sealing faucets. So if you ever want to replace or upgrade your beer faucet, we've got what you need!



Stainless Steel Beer Faucet - Stainless Lever

Heavy-duty 304 stainless steel body makes it perfect for bars and other heavy use environments. A non-stick ball washer ensures smooth operation.



Stainless Steel Self-Closing Beer Faucet

This faucet is fitted with an ABS plastic shaft with self-closing, spring-loaded action that closes the faucet when the lever is released.



Guinness® Dispensing Stout Beer Faucet

This features a restricted spout that contains a tiny disc. The restrictor disc helps slow down the pour and allows the beer to pour properly.



Perlick PERL Faucet

These stainless steel Perlick faucets feature a forward sealing design. The revolutionary Perl ball and floating O-ring design eliminates the need for a valve shaft so the faucet will not stick.



BEER LINE CLEANING KIT

Beer Dispensers need to be clean to function and dispense properly. This hand pump pressurized kit does not require you to remove your faucet to clean your system, connecting directly to your beer line for fast and easy cleaning. It includes a 32 oz. bottle of biodegradable alkaline beer line cleaning solution and a nylon faucet brush to scrape off any stubborn particles from the system fittings.

BEER GROWLERS

Take your beer with you in one of our stainless steel beer growlers when you go to parties, the beach, camping or events that don't allow glass bottles. Their double wall design will maintain cold for up to 24 hours and they are passivated to ensure tap fresh flavor without any off tastes.



TAP HANDLES

Personalize your kegerator with one of our amazing portfolio of unique tap handles. We offer colorful pub-style tap handles and chalkboard or white board tap handles that can be customized to display the beer you have on tap.

FOR MORE GREAT DEALS ON KEGCO PRODUCTS, VISIT BEVERAGEFACTORY.COM

THERMOSTAT CONTROL UNIT

The Kegco TC-321 allows you to convert any refrigerator or freezer in to a kegerator and fermentation chamber by overriding the appliance's thermostat. By regulating the amount of energy that gets to the appliance, you can have very precise control over the temperature settings and the amount of temperature fluctuation between cycles. Remote sensors allow it to monitor the temperature inside the appliance without opening and closing the door, keeping the internal temperature consistent while providing a digital readout to see the current setting at a glance. With a setpoint range of -40° to 100° Fahrenheit, it provides a wide variety of uses. Ensure every glass is dispensed at the optimal temperature or take control of your fermentation environment to ensure consistent results time after time.



HOME BREW KEGS

Keg and dispense your own home brewed recipes with these 304 Grade Stainless Steel Ball Lock Kegs. We have 3 and 5 gallon options and either strap or rubber handle designs to suit your needs.

GLASS CARBOYS

Carboys are used worldwide in the fermentation process for home brewed beer, wine and kombucha, and can also be used to make and store iced tea or cold brewed coffee. Whether you prefer a 5 or 6 gallon carboy or a wide mouth jar, Kegco has got what you need!

